

**IQUBX
GREEN CERTIFIED**

**MODULAR
FURNITURE &
INTERIOR SYSTEMS**





designers & manufacturers

largest number of
Green certified modular interior systems
in India

With more than 80 certificates till date



◀ widest range of modular interior systems ▶



Glass partitions



Glass doors & frame



Demountable partitions



Drywall cladding partitions



Paneling



Baffle ceilings



Ceiling trapdoors



Workstation & Table leg systems



Floor Junction box



Floor raceways

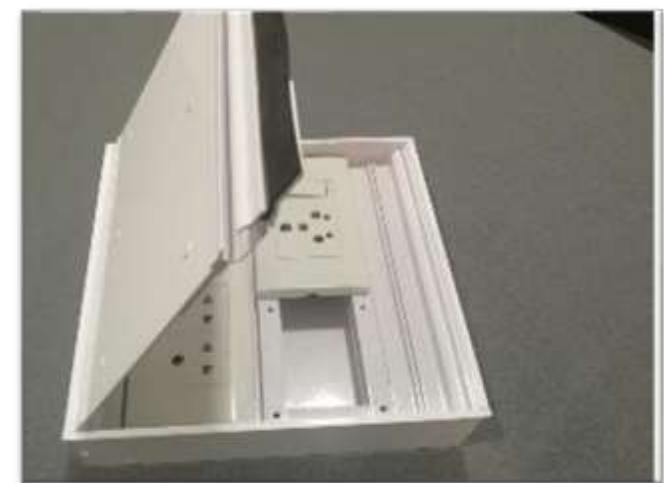

Floor Boxes

innovative | quick to install | highly customizable

+91 9999001967, 8506074444

Largest number of **GREEN CERTIFIED MODULAR INTERIOR SYSTEMS** IN INDIA

Very innovative and green certified, IQUBX modular interior systems can help create offices ultrafast with minimum human labour and very economic cost. These systems can be easily modified, making such spaces very adaptable and flexible to cater to changing future requirements. We can provide custom modular solutions for your requirements as well.



www.iqubx.com

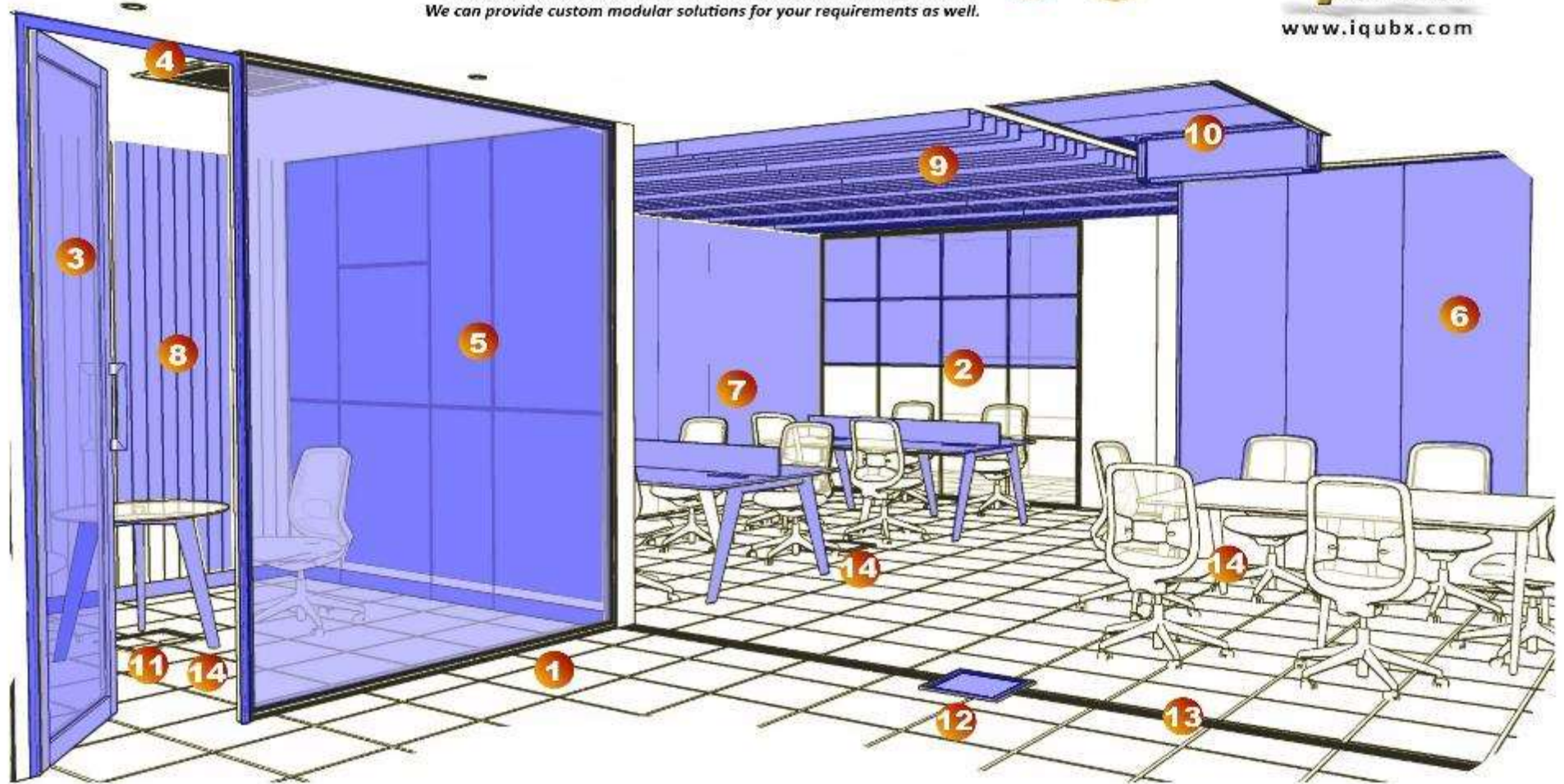

IQUBX for COMMERCIAL OFFICE & CO-WORKING SPACES

- 1 Glass partition
- 2 Grid glass partition
- 3 Glass stile door
- 4 Modular Door frame
- 5 Demountable wall partition
- 6 Dry wall stone / tile / paint partition
- 7 Wall paneling
- 8 Aluminium wall paneling
- 9 Baffle ceiling
- 10 Ceiling trap door
- 11 Floor junction box
- 12 Floor box
- 13 Raceway
- 14 Modular table leg system

Offices
& Coworking
space





iqubx

airports

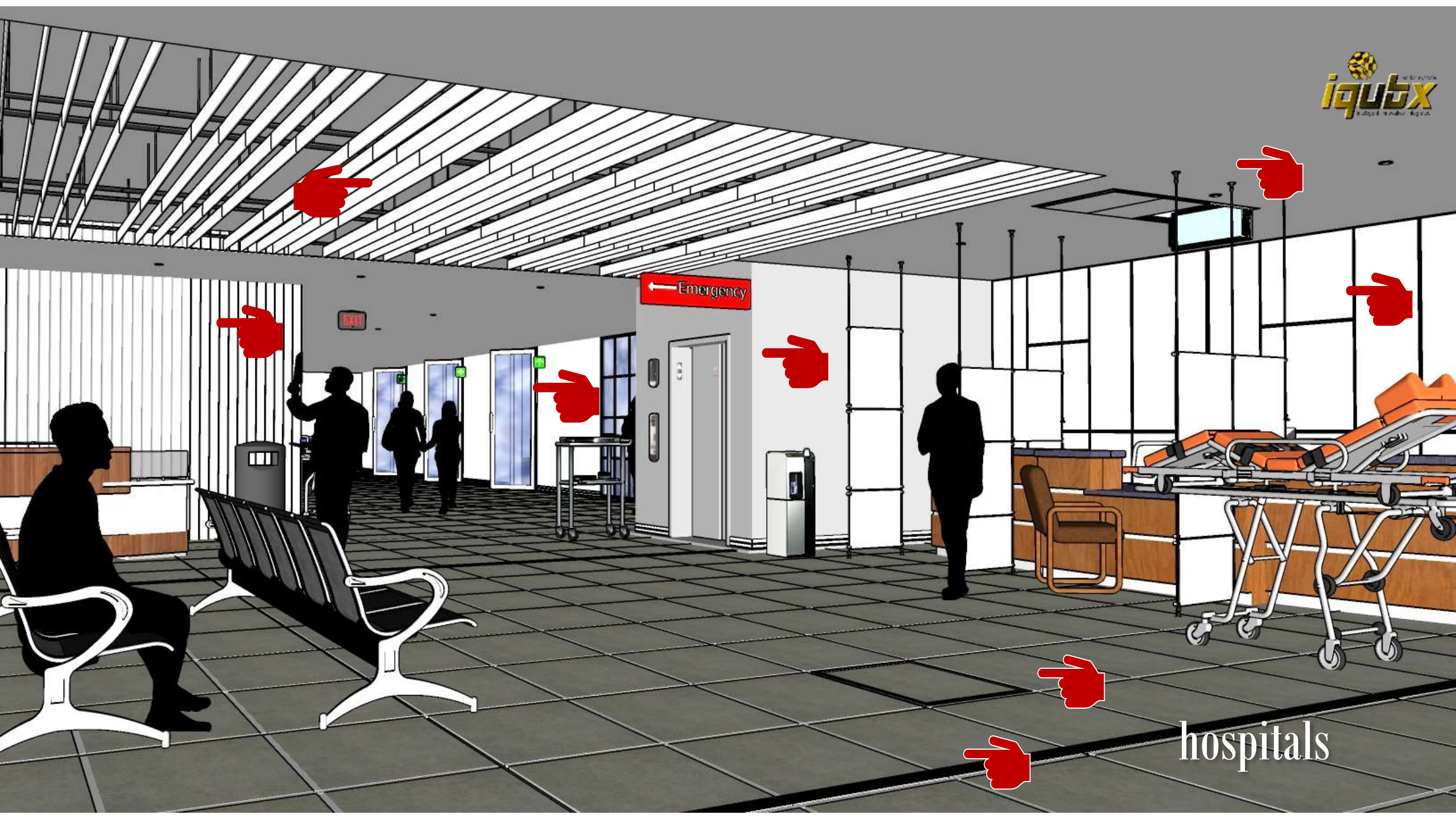

← Emergency

hospitals



Architects & designers

Flexible in design for **unique aesthetic expression** of architects & designers



End Users

Highly customizable for better product-user fit and **changeable** as per future requirements, **green certified** for additional benefits

Contractors

Reduce time from many weeks to days with minimum labour



Benefits to
stake holders
in Interior projects

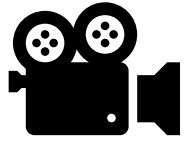

[Click here to
Watch intro video](#)



**Green certified innovative
modular interior systems**

Make in India



**Greenpro certified
by IGBC, CII**



**Economic Times
Award**



Manufacturers of largest number of **green certified** modular interior systems in India



IQUBX is
Manufacturers of largest number of
green certified modular interior
systems in India
with over 80 certifications. Most of the products are the only certified products in India in their respective categories.
All products certified by Indian Green Building Council, a CII body



Iqubx products can help in achieving following credit points

New Building (Commercial Buildings)

- BMR Credit 1 - Sustainable Building Materials (upto 4 Points)
- BMR Credit 4 - Use of Certified Green Building Materials, Products & Equipment (1 Point)
- IEQ Credit 5 - Low-emitting Materials (1 point)
-

In Green Homes (Residential Buildings)

- MR Credit 3 - Certified Green Products (1 point)
- MR Credit 4 - Local Materials (upto 2 points)
- RHW Credit 5 - Low VOC Materials, Paints & Adhesives (upto 1 point)



IQUBX has relevant certifications with government authorities and is a DIPP registered startup in India. We also have ISO certification.

भारत सरकार
Govt. of India
सूक्ष्म, लघु और मध्यम उद्यम विभाग
MINISTRY OF MICRO, SMALL & MEDIUM ENTERPRISES

MSME
सूक्ष्म, लघु और मध्यम उद्यम
MICRO, SMALL & MEDIUM ENTERPRISES

उद्योग आधार
MSME
Udyog Aadhaar

A

Type of Enterprise	Micro	Small	Medium
Manufacturing	A	B	C
Services	D	E	F
UAM	DL11A0004509		

Udyog Aadhaar Acknowledgement

Udyog Aadhaar Number: DL11A0004509
Name of Enterprise: IQUBX PRIVATE LIMITED
Location of Plant Details:

Sl. No.	Floor/Block No.	Name of Premises/Building	Village	Road/Street/ Lane	Area/Locality	City	Pin	State	District
1	B-9, GROUND FLOOR	KIRAN GARDEN		MAIN MATIALA ROAD	UTTAM NAGAR	NEW DELHI	110069	DELHI	WEST DELHI

Official Address of Enterprise: B-16, GROUND FLOOR, MAIN MATIALA ROAD, UTTAM NAGAR
District: WEST DELHI, State: DELHI, Pin: 110059
Mobile No: 9812048111, Email: AMT@IQUBX.COM

Date of commencement: 25/05/2017
Major Activity: MANUFACTURING
Enterprise Type: Micro
Previous Registration details if any: DL11A0001589
National Industry Classification Code:

SN	MC 2 Digit	MC 4 Digit	MC 5 Digit Code	Activity Type
1	32 - Manufacture of rubber and plastics products	3220 - Manufacture of plastics products	32207 - Manufacture of moulded educational accessories of plastic (including electrical insulating fitting of plastic)	Manufacturing
2	32 - Manufacture of rubber and plastics products	3220 - Manufacture of plastics products	32209 - Manufacture of other plastics products n.e.c.	Manufacturing
3	34 - Manufacture of basic metals	3420 - Manufacture of basic products and other non-ferrous metals	34202 - Manufacture of Aluminium from alumina and by other methods and products of aluminium and alloys	Manufacturing
4	35 - Manufacture of computer, electronic and optical products	3510 - Manufacture of electronic computer parts	35103 - Manufacture of integrated circuits (semiconductors)	Manufacturing
5	35 - Manufacture of computer, electronic and optical products	3510 - Manufacture of electronic computer parts	35109 - Manufacture of other electronic components n.e.c.	Manufacturing
6	37 - Manufacture of electrical equipment	3733 - Manufacture of wiring devices	37331 - Manufacture of switch, switch box, lamp holders, fuses etc.	Manufacturing
7	37 - Manufacture of electrical equipment	3740 - Manufacture of electric lighting equipment	37400 - Manufacture of electric lighting equipment	Manufacturing
8	74 - Other professional, scientific and technical activities	7410 - Specialized design activities	74109 - Other specialized design activities n.e.c.	Services

Acknowledgement Date of Filing: 20/07/2017, Date of Printing: 20/07/2017

Disclaimer: This is computer generated statement; no signature required
Printed from: udyogaadhaar.gov.in

MSME Mobile App (Beta Version) is available now for download: www.msme.gov.in/MSME-Mobile-App

iqubx interior systems
intelligent innovative integrated

GreenPro
Certification of Green Industry

GreenPro
CII-Green Products and Services Council
This certifies that **Baffle Ceiling System 1 (BFC01)** (CPIPS 1006) manufactured by **IQUBX Private Limited** at their plant in Delhi meets the requirements of GreenPro Certification and qualifies as a Green Product.
This certification is valid till **December 2018**

Department of Industrial Policy & Promotion
Ministry of Commerce & Industry
Government of India

CERTIFICATE OF RECOGNITION
Department of Industrial Policy and Promotion

This is to certify that **IQUBX PRIVATE LIMITED** incorporated/ registered as a **Private Limited Company** on **25-05-2017**, is recognized as a startup by the Department of Industrial Policy and Promotion.

Date of Issue: 03-12-2018
Place of Issue: New Delhi

The certificate shall only be valid for the entity:
- Up to seven years from the date of its incorporation/ registration; and
- If its turnover for any of the financial years since incorporation/ registration has not exceeded Rs. 25 crores.

Note:
- **Authorities accepting this Certificate may check its validity on the Startup India portal (<https://www.startupindia.gov.in/>)**
- This certificate is not the Certificate issued by the Inter-Ministerial Board and is NOT VALID for availing Tax benefits
- This is a system generated certificate and hence does not require physical signature
- If such recognition is found to have been obtained without uploading the relevant documents or on the basis of false information, DIPP reserves the right to revoke the recognition certificate immediately without any prior notice or reasons.

Otabu
Certificate of Registration

This is to certify that the **IQUBX PRIVATE LIMITED**
B-19, G7, Kiran Garden, Main Matiala Road, Uttam Nagar,
New Delhi-110069, India
has been assessed and Certified by Otabu Certification Limited
as meeting the requirements of

ISO 9001:2015
Quality Management System

For the following scope of activities:
"Design, Manufacturing and Tracking of Floor Trunking System, Floor Junction Box, Floor Recessed Systems, Wall Paneling, Skirting & Chair Rail, Glass Partition System, Modular Partition System and Raised Access Floor, Lighting System, BMS Systems and Other Modular Interior Systems"

Date of Registration: 20th July 2017
1st Surveillance Due: 19th July 2018
2nd Surveillance Due: 19th July 2019
Recertification due (subject to the company's performance): 19th July 2020

Certificate Number: 300200717
Validity of this certificate can be verified at www.otabucert.co.uk

Otabu Certification Limited (UK)
Validity of this Certificate is subject to Annual Surveillance audits done successfully
The Certificate is registered under the Property of Otabu Certification Limited and will be invalid otherwise
Small companies are welcome to apply. Website: www.otabucert.co.uk
Suite 48, 88-90 Hutton Gardens, London, EC1N 8PN, UK

Awards & Recognition



IQUBX was awarded the coveted **Emerging consumer brand of the year** in year 2020 by **Economic Times**





iqubx
intelligent innovation integrated

Features & benefits



Very **innovative**



Unique, different and **patent applied**

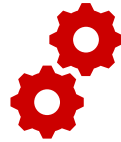

Sophisticated engineering



Very High **performance**



Made completely in **India**

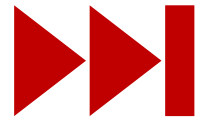

Ultra **fast** installing



Minimum Human **labour** on site



Highly **Customizable, Modifiable, Relocatable**
in future as per requirements



Very **economic** pricing

We deliver the promised value proposition because of our core structure and philosophy

MODULARity

MODULARity

MODULARity

Lean & Agile

Manufacturing

Asset light organization

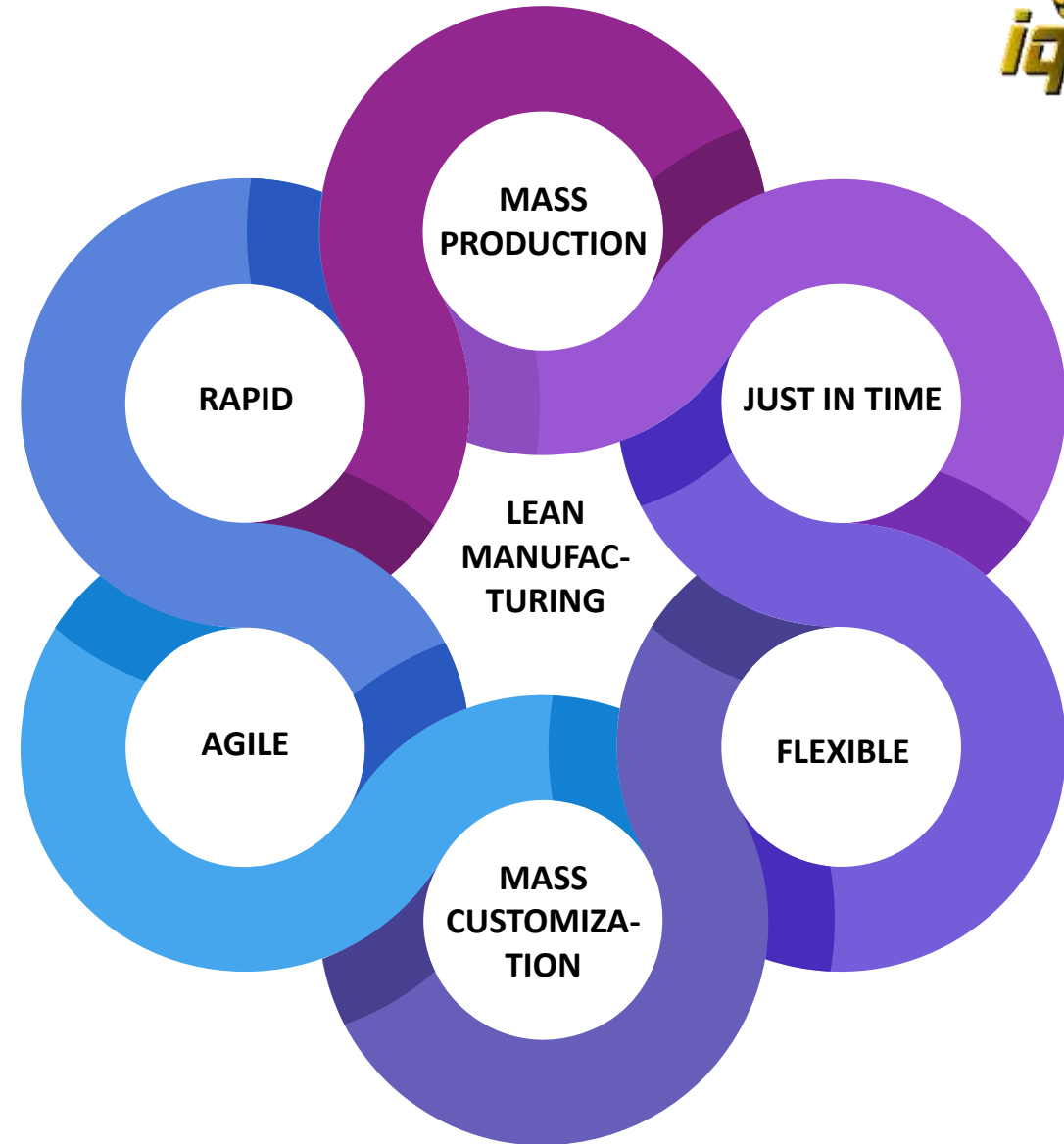



**IQUBX
GREEN CERTIFIED**

GLASS PARTITION SYSTEMS



*To download brochure,
go to the webpage*

Go to webpage



High performance

High acoustic insulation – noise reduction and privacy

Modifiable

In some models, Single glass can be upgraded to double glass and VIG glass for more acoustic performance any time

Fast installation

Highly engineered sections and joinery can reduce time of installation by half

Relocatable

Wide range of options



GP2160S

21 X 60 mm



GP2160D

21 X 60 mm



GP4028

40 X 28 mm



GP2510/12

25 X 44 /50 mm



GP2512D

25 X 100 mm

18 X 100 mm
GP18100VIG



18 X 100 mm
GP18100S



18 X 100 mm
GP18100D



20 X 60 mm
GPC2060



14 X 15 mm
GPC1415



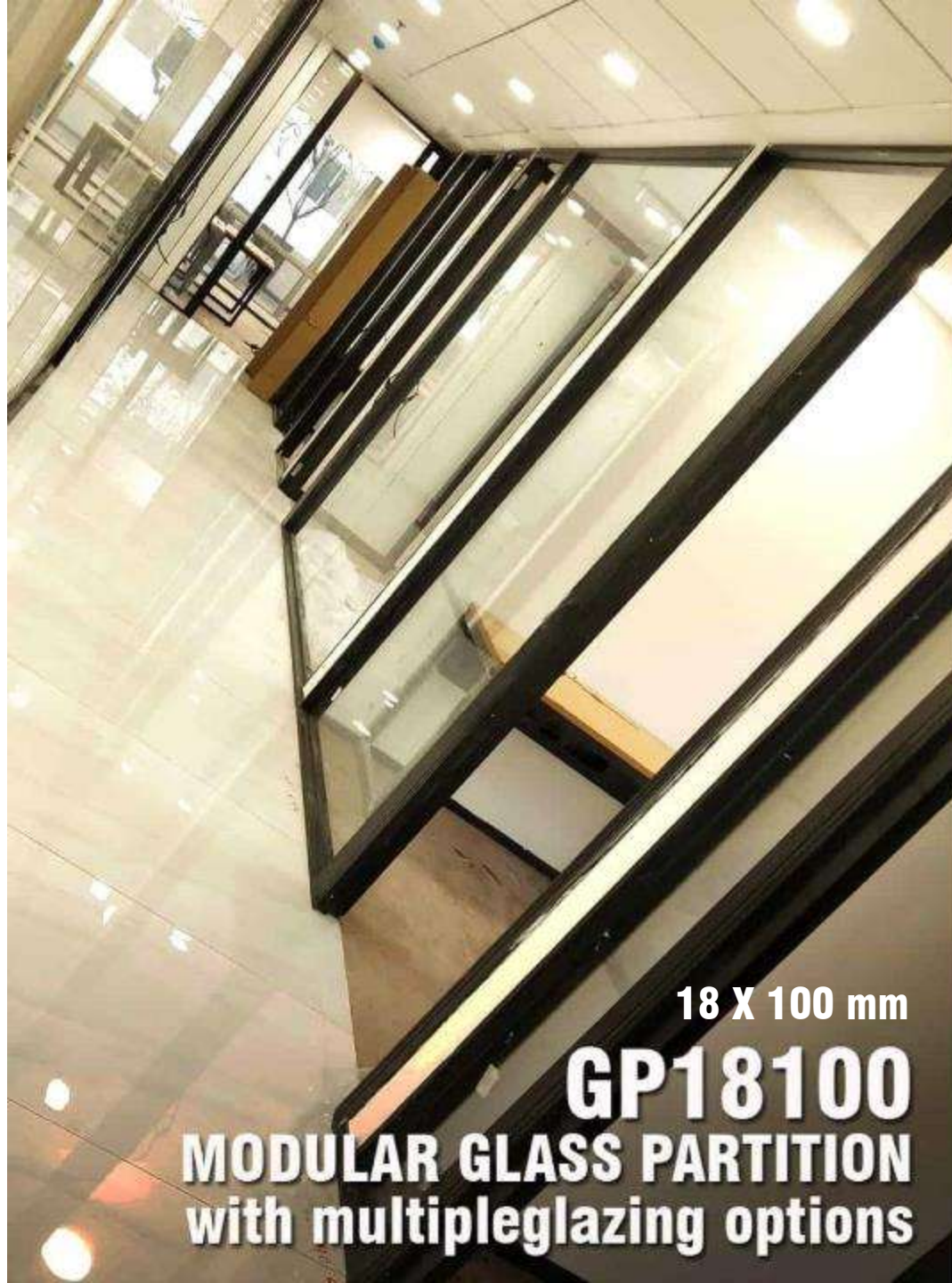

18 X 100 mm
GP18100
 MODULAR GLASS PARTITION
 with multiple glazing options



Same system can be fitted with single glass, double glass or vacuum insulated glass any time
GP18100D is STC54 certified

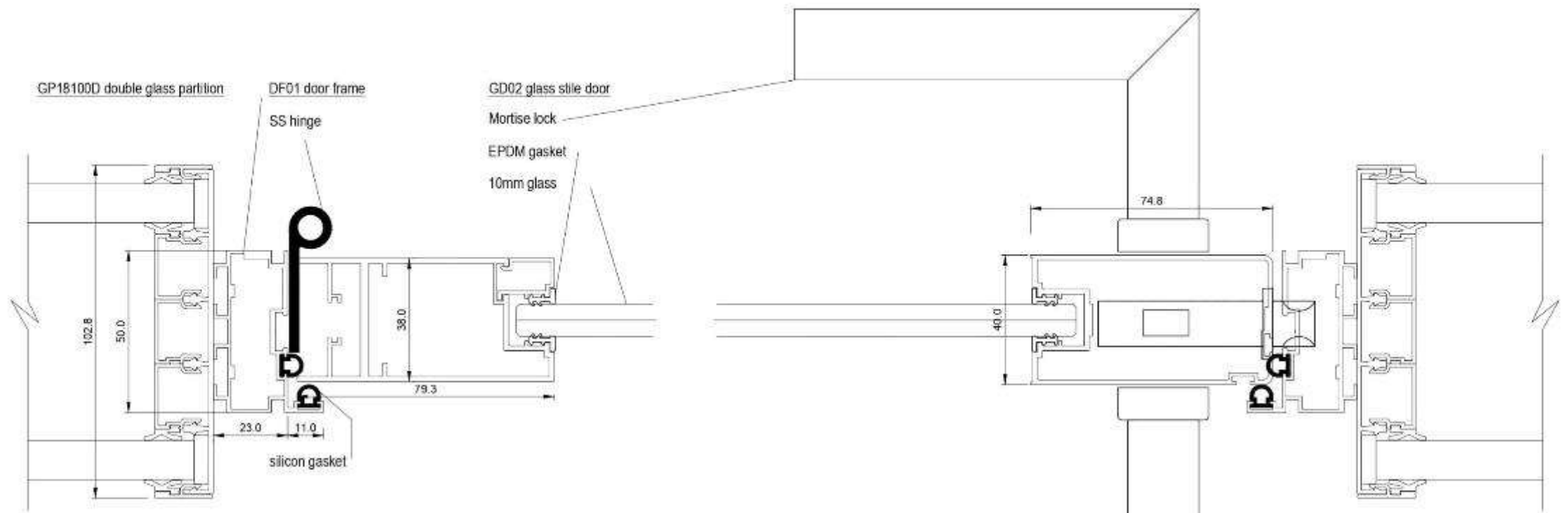

Assembly of Glass partition GP-18100D with Door frame DF01 and glass door GD02

GP18100a outer frame

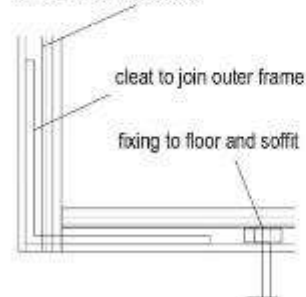

GP18100b & c snapfit mouldings fixed to base channel frame

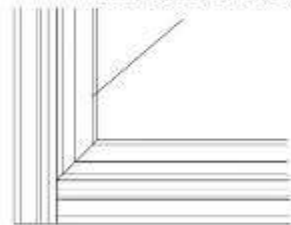

Joining of mouldings and outer frame as seen from outside

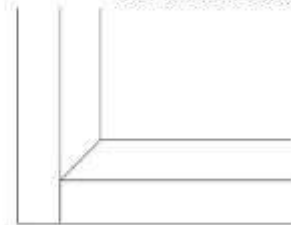

GP-18100D assembly of components and fixing

IQBX GD02

- Modular Aluminium stile Door - for single glass 8 - 10mm
- Proprietary design made and produced in India
 - usable for hinge as well as sliding applications
 - Glass installation or change does not require door demounting
 - IGBC GREENPRO certified by IGBC, CII
 - 100% recycled aluminium
 - 30% Pre-consumer and 70% Post-consumer

IQBX DF01

- Modular Aluminium universal Door frame - for glass & demountable partitions, gypsum and masonry walls
- Proprietary design made and produced in India
 - Double door seal for better sound proofing
 - IGBC GREENPRO certified by IGBC, CII
 - 100% recycled aluminium
 - 30% Pre-consumer and 70% Post-consumer



GP18100

GP18100



Glass partitions



GP18100

Glass partitions

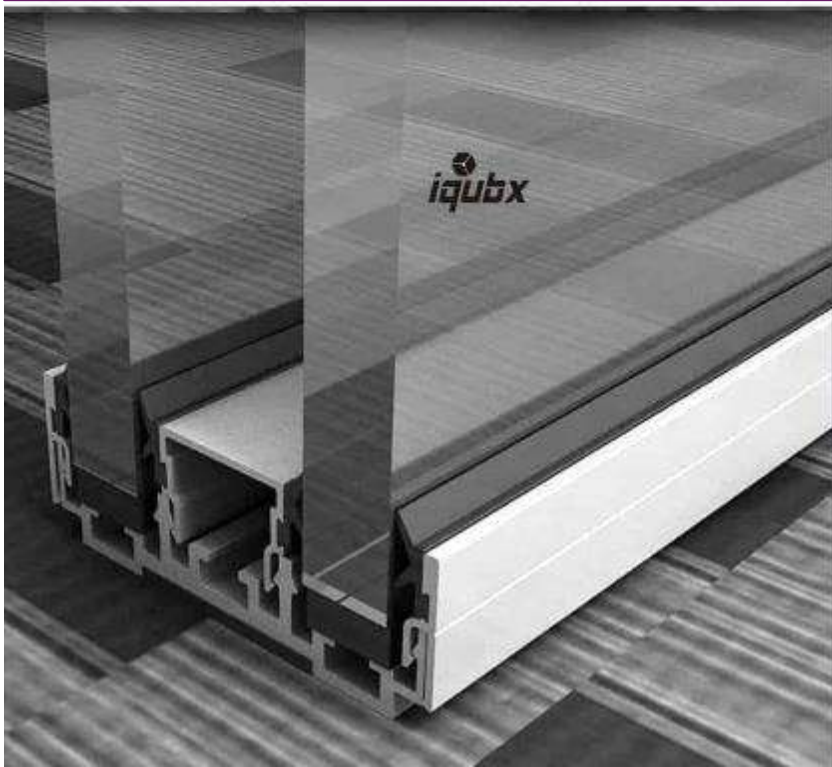
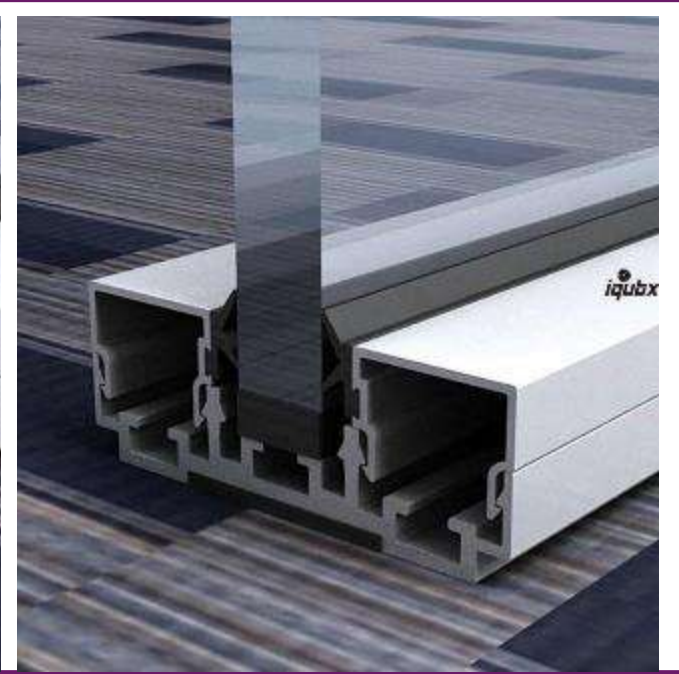

GP2160D

MODULAR GLASS PARTITION
21 x 60 mm, Multi-glazing option glass partition system with sleek aesthetics & superior acoustics

40 X 28 mm
GP4028
MODULAR GLASS PARTITION

Single glass partition system
with superior acoustics & bold aesthetics



double lock
edge channel
for strong locking
and strong frames
construction
with brackets





GP2510/12



GP2512D

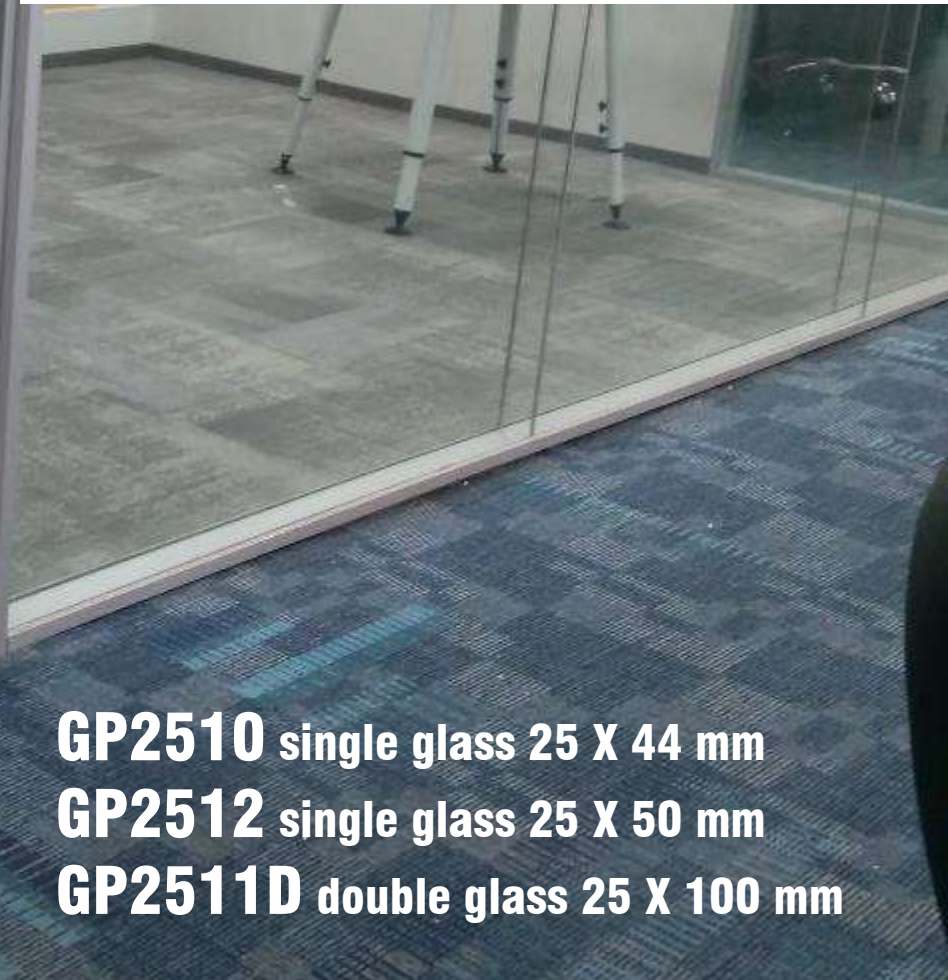

GP2510 single glass 25 X 44 mm
GP2512 single glass 25 X 50 mm
GP2511D double glass 25 X 100 mm

This is indicative image from catalogue



GPC1415 faux
modular grid 14 X 15 mm
GPC2060 real
modular grid 20 X 60 mm

Grid Glass partitions

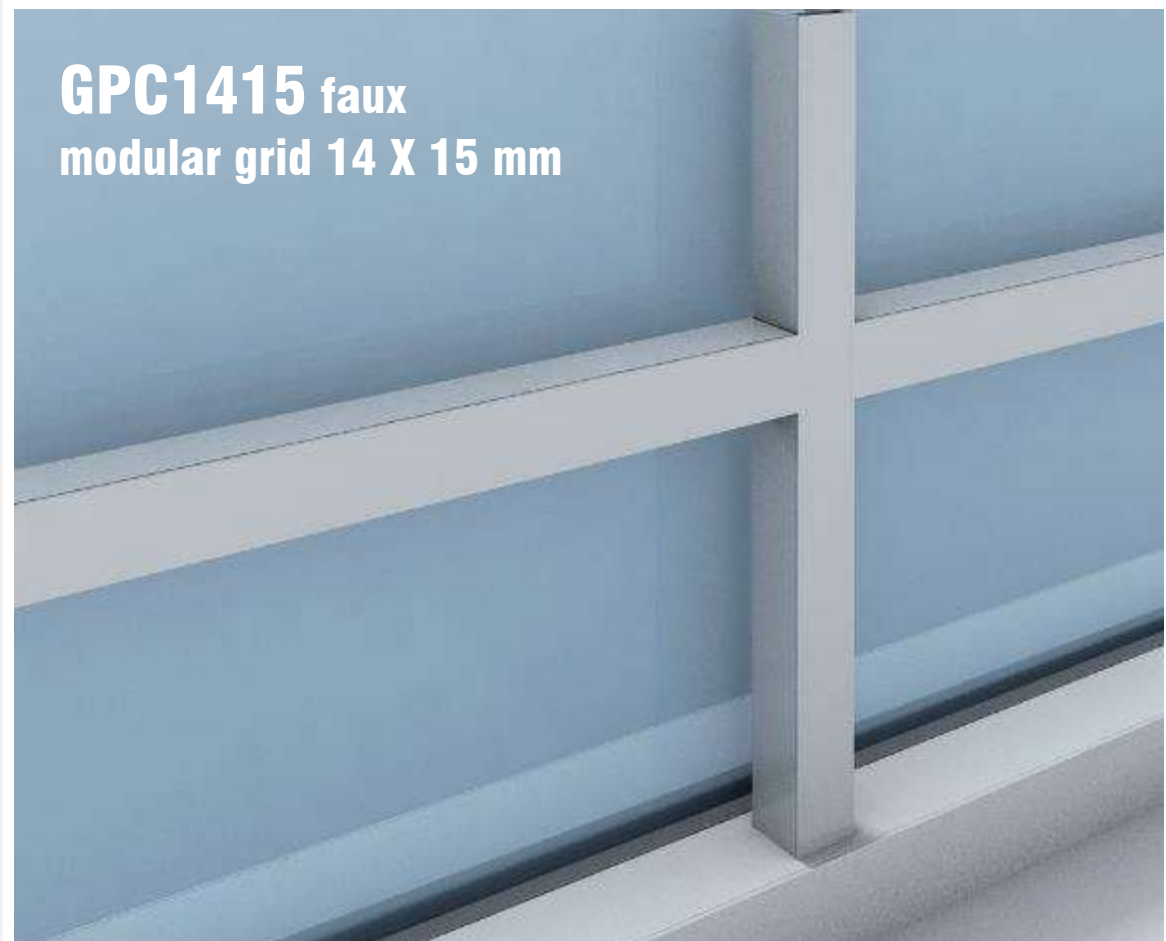



**IQUBX
GREEN CERTIFIED**

**DOOR
FRAME DF01 50X23**



*To download brochure,
go to the webpage*

Go to webpage



High performance

High acoustic insulation – double door seal in frame

Very high frame strength with strong joinery

Universal design

The design is sleek and strong and independently framed, making it usable in modular glass partitions, gypsum or other demountable partitions, masonry walls

Fast installation

Highly engineered sections and joinery can reduce time of installation by half

Relocatable

Suitable for use with
most of hardware
including concealed
door closer



Modular Glass door & frame

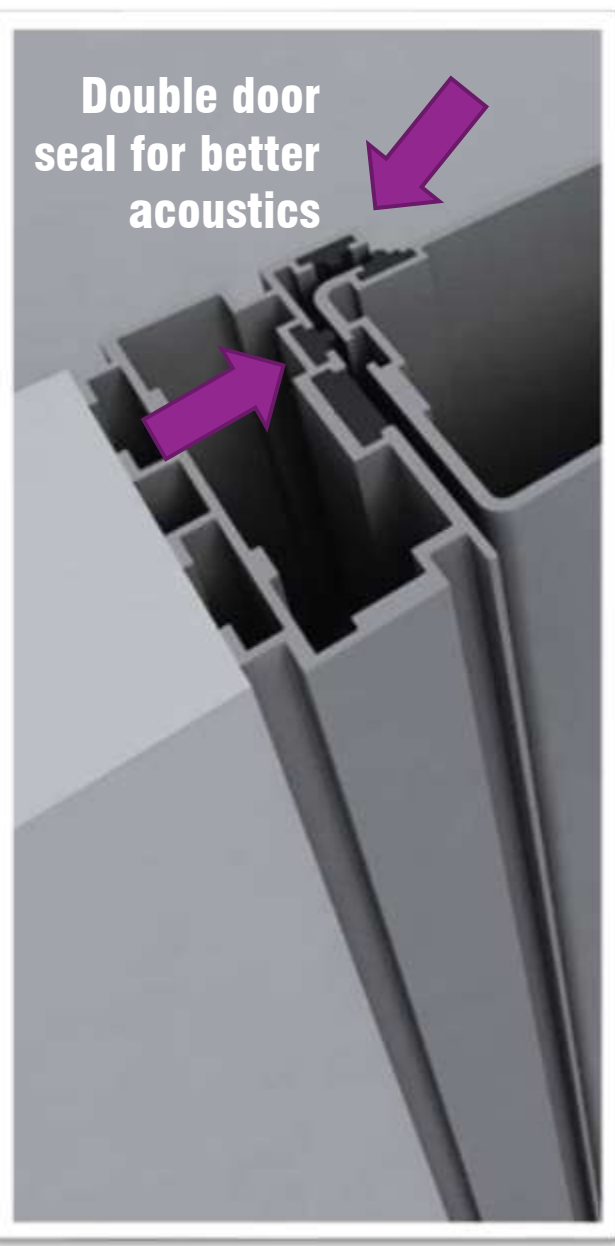

The design is sleek and strong and independently framed, making it usable in modular glass partitions, gypsum or other demountable partitions, masonry walls

DF01 ALUMINIUM DOOR FRAME



IQUBX
GREEN CERTIFIED

GLASS
DOORS GD01-02



*To download brochure,
go to the webpage*

Go to webpage



High performance

Double door seal for acoustic performance and soft closing
Very high frame strength with strong joinery

Innovative design

GD01 design is very innovative and has wide impressive lock stile with integrated handle and option of single & double glass / VIG glass
GD02 is strong, sturdy and sleek single glass option

Fast installation

Highly engineered sections and joinery can reduce time of installation by half

Relocatable



Single Glass &
Double Glass
pane options

Integrated handle
on both sides

- options of single and double glass
- integrated handle
- glass panel can be changed without door removal
- unique design
- made of 100% recycled aluminium
- can be used with IQUBX door frame DF01
- Sliding option GD01S available

No need to remove door to change or install glass
Sliding option GD01S available
Lock stile 138 x 40 hinge stile and rails 92 x 40

GD01 ALUMINIUM GLASS DOOR



GD01S
ALUMINIUM GLASS DOOR
SLIDING



**No need to remove
door to install glass**

**Sliding option
GD02S available**

**For single glass
8 to 10mm**

**GD02
ALUMINIUM
GLASS DOOR**

**Stiles 75 x 40
Rails 92 x 40**



No need to remove door to install glass
Sliding option GD02S available

GD02
ALUMINIUM GLASS DOOR



**GP18100
MODULAR GLASS PARTITION
with multiple glazing options**

**DF01
ALUMINIUM
DOOR FRAME**

**GD02
ALUMINIUM GLASS DOOR**

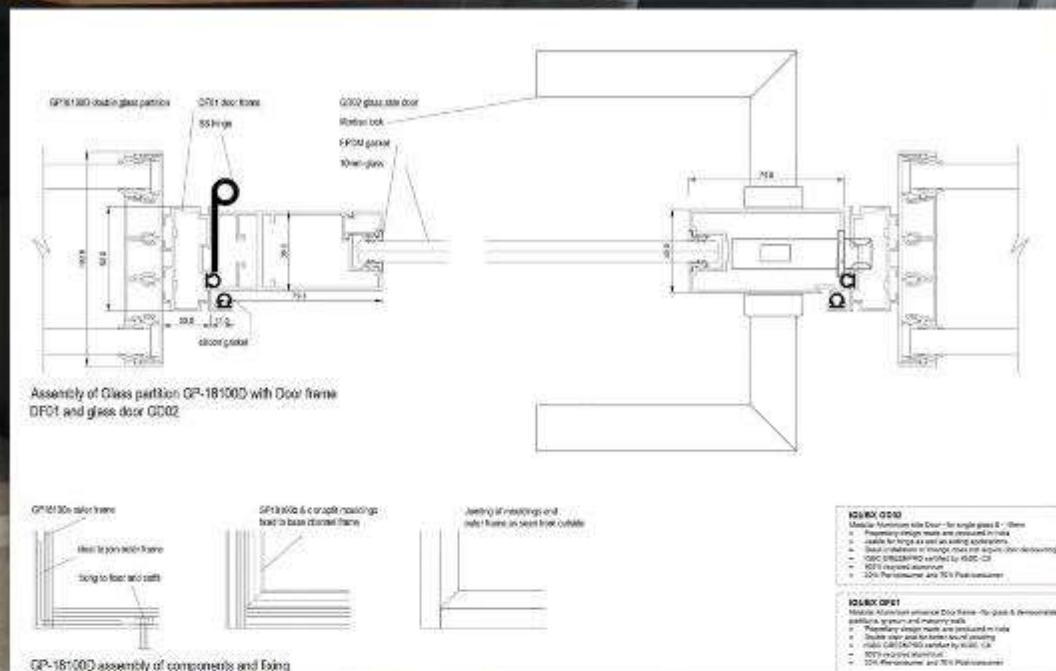



**IQUBX
GREEN CERTIFIED**

**DEMOUNTABLE
PANELING &
PARTITIONS**
WP01, WP01P, WP03P

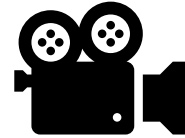

[Click here to
Watch
product
video](#)

*To download brochure,
go to the webpage*

[Go to partition
webpage](#)



[Go to paneling
webpage](#)



High performance

High acoustic insulation with multiple gaskets and continuous acoustic insulation inside

Removable Panels

Allows changing panels finishes like installing glass writing boards etc any time as well as, maintain and changing electrical wirings / plumbing etc inside

Or install switch sockets at a location
Multiple finishes like lacquered glass, laminated ply, prelaminated boards, veneered ply, soft board, HPL

Fast installation

Efficient system design reduces labour and time of execution by more than half

Relocatable



WP01, WP01P, WP03P

Frame thickness

50 mm

Partition thickness

60 mm with 6mm HPL skin

75 mm with 12mm skin

100 mm with 25mm skin



Paneling
done in an
office in
Pune by
Architect
Aijaz Hakim

- * Post and rail with panels modular construction
- * Very fast to install and Very cost effective
- * Continuous cavity for conduits and acoustic insulation
- * Panels fixed with continuous gasket for acoustic insulation
- * Anytime Changable panels with lot of options like Prelaminated board, laminated MDF, lacquered glass, soft board, cork board - allows post-construction flexibility as well as access for maintenance of embedded services

WP03Pa post section

WP03Pb rail section



**IQUBX WP03P
DEMOUNTABLE
WALL PARTITION SYSTEM**



WP03Pc hook section

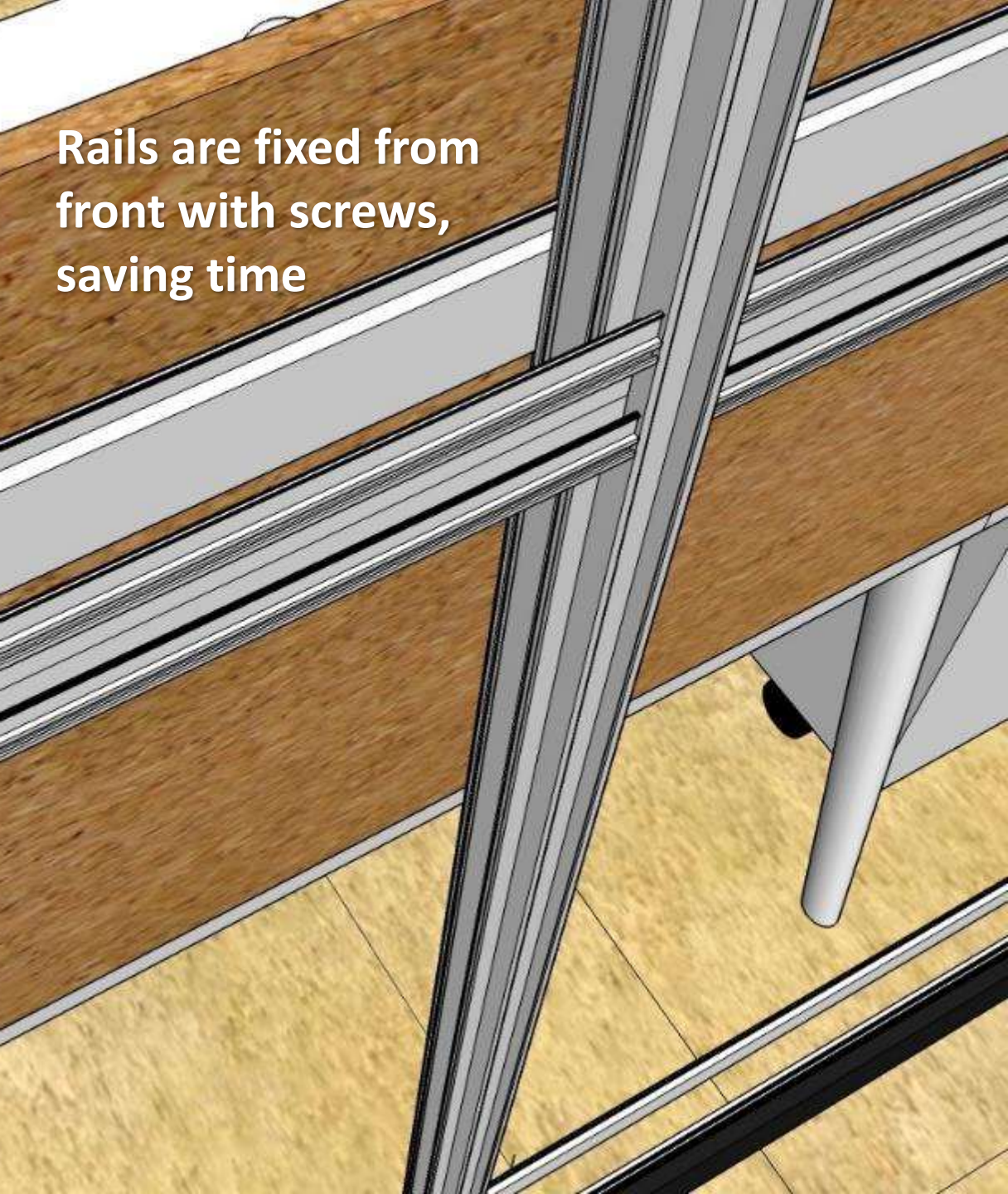

**Framing for demountable
partitions**

A close-up 3D rendering of a metal rail being installed on a wooden desk. The rail is a silver-colored extrusion with a channel on its top surface. It is being secured to the desk's edge with screws. The desk has a light-colored wood grain finish. The floor is a light-colored wood-look laminate.

Rails are fixed from front with screws, saving time

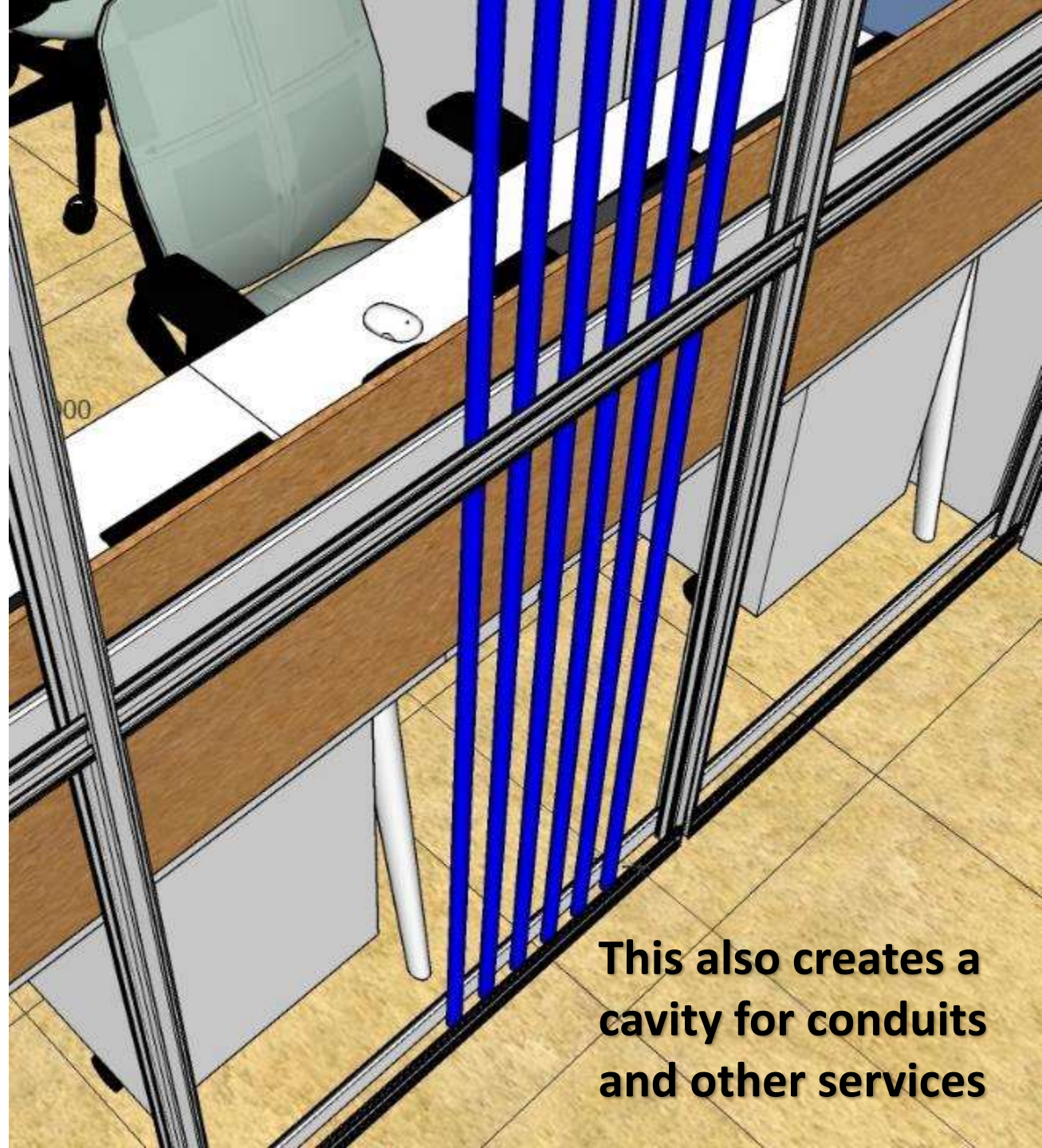
A 3D rendering of a desk with a blue slatted railing. The railing consists of several vertical blue bars held together by horizontal silver-colored metal rails. The desk is made of wood and has a white mouse on the surface. A light green office chair is visible in the background. The floor is a light-colored wood-look laminate.

This also creates a cavity for conduits and other services

**The skin is fixed
with help of hook
section**



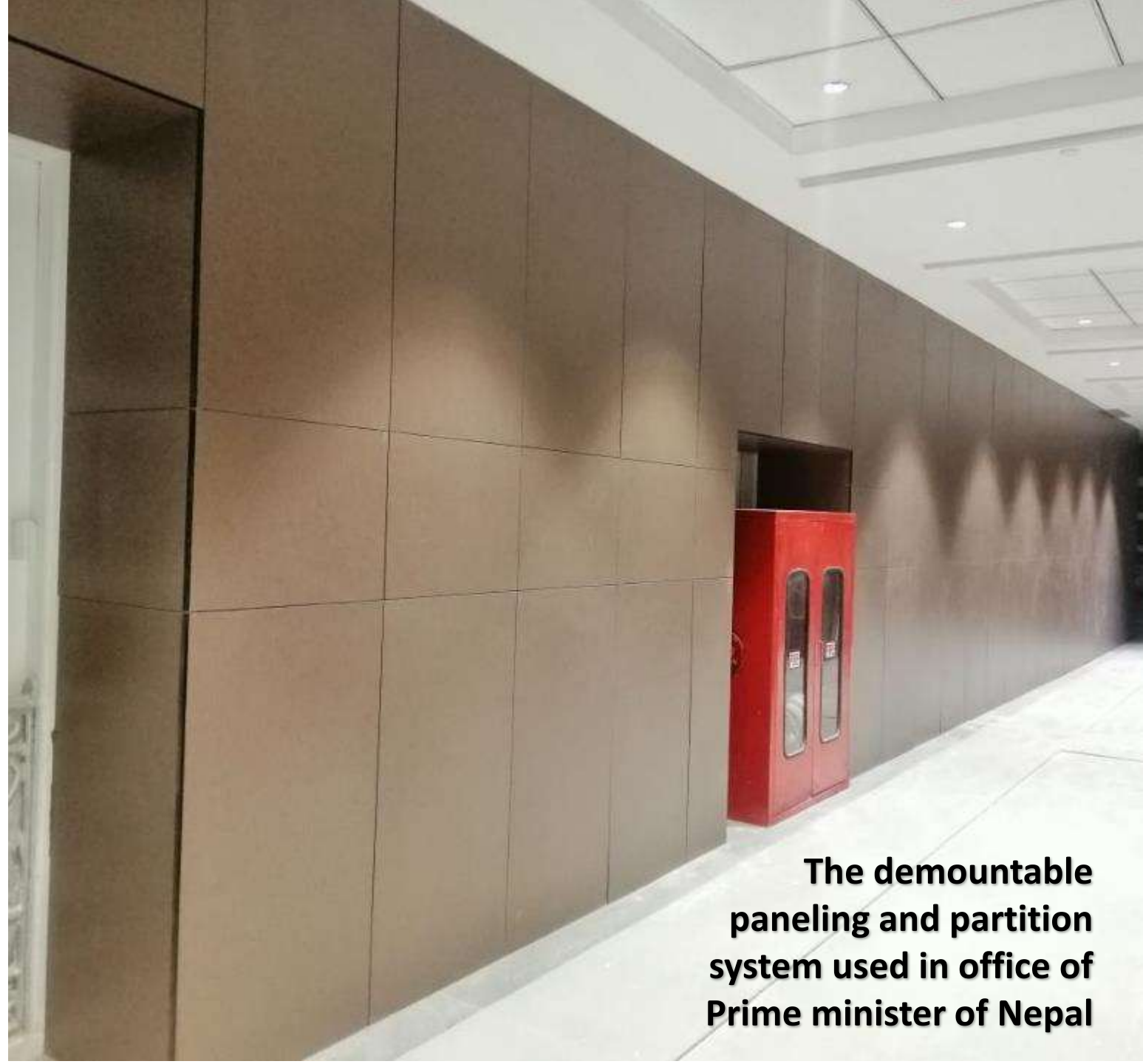

The demountable paneling and partition system used in office of Prime minister of Nepal



[Click here to
Watch
product
video](#)

With IQUBX modular partitions, that extra room or toilet in your stilt parking or garage can be created in just a couple of days.

You can have removable panels with finishes of stone, tile, laminate or plain paint.

With low budget and without violating the building byelaws, these modular partitions can be removed or relocated within a couple of hours.

They are truly temporary but with a feel of permanence.

Demountable partition & paneling



**IQUBX
GREEN CERTIFIED**

**DRY WALL
CLADDING
PANELING &
PARTITION DWP01**



*To download brochure,
go to the webpage*

Go to webpage



100% dry construction

Complete dry frame with high engineered section installed by a single team in 1 stage

Removable panels

Allows changing panels finishes any time as well as maintain and changing plumbing inside

Fast installation

Being a single stage construction with precut stone, tile or HPL panels, ultra fast construction – can bring down construction time from many weeks to a few days

Relocatable

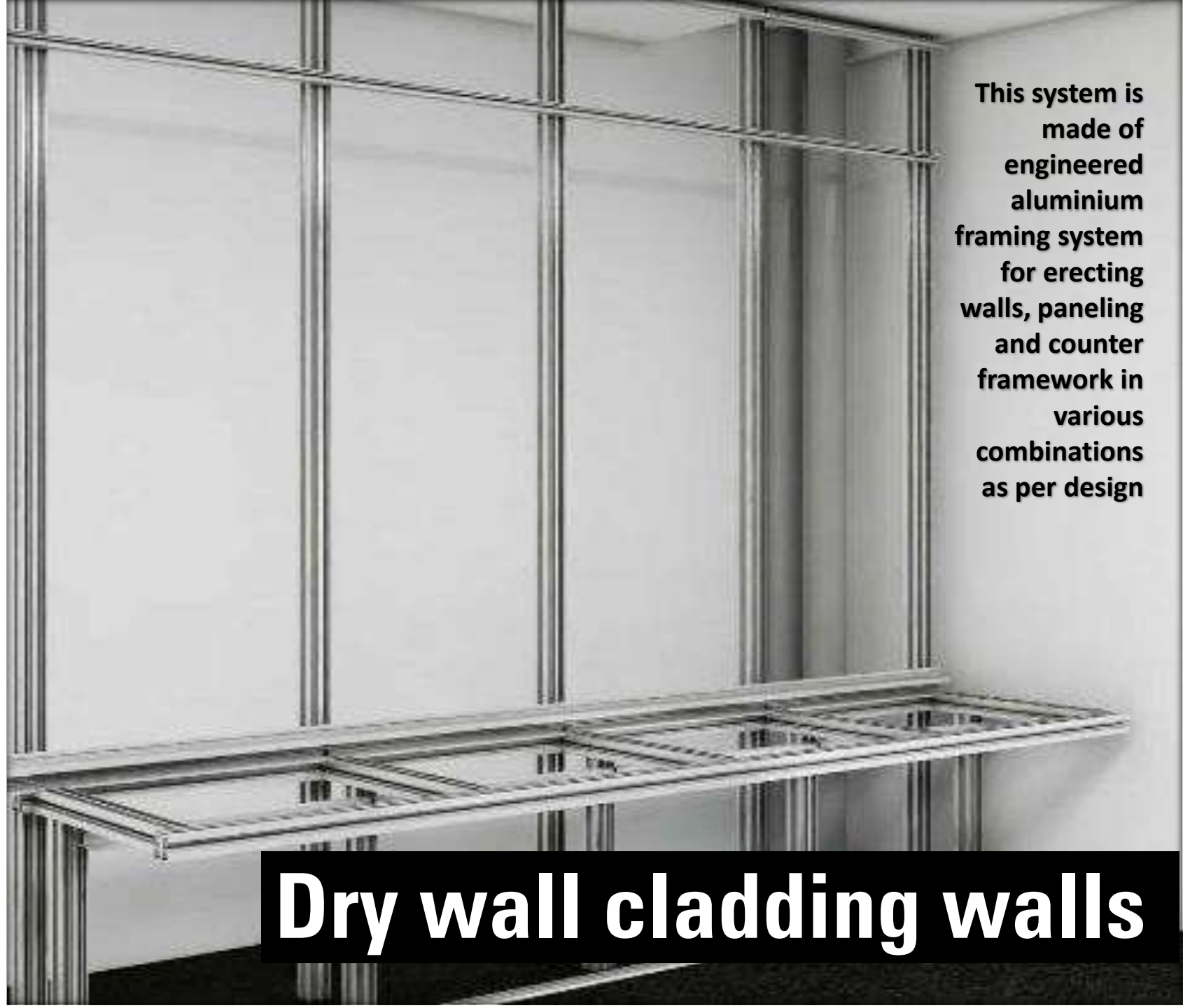

**This system is
made of
engineered
aluminium
framing system
for erecting
walls, paneling
and counter
framework in
various
combinations
as per design**

Dry wall cladding walls

The framework is then clad with 18mm thk approx. stone panels, tiles pasted on suitable base, or bison board and HPL combination etc



Dry wall cladding walls

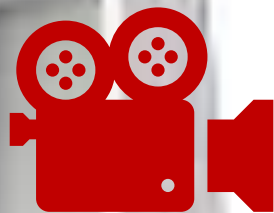

DRY WALL CLADDING ROOM PARTITION





IQUBX
GREEN CERTIFIED

PANELING

WP75
WP02

*To download brochure,
go to the webpage*

Go to WP75
webpage



Go to WP02
webpage



WP75

Very rhythmic fluted pattern
aluminium interlocking panels on walls
or partitions
Perfect pattern aesthetics
Very quick to install with pre-finished
panels
Can be cladded on straight or curved
walls

WP02

Very economic snap-fit system to panel
any 12mm material
Each panel removable separately
Innumerable patterns of panel possible
Ultra fast to install
Relocatable - modifiable

WP75

Suitable for cladding on furniture, walls, columns – straight or curved surface







The wall panel material can be any 12 mm thick material panel like Gypsum board, calcium silicate board, clear glass, lacquered glass, wood, pre-laminated board or ply, soft board, acoustic board ..



IQUBX WP02 SNAP-FIT WALL PANELING



**IQUBX
GREEN CERTIFIED**

CEILING TRAPDOOR

**CTD 23
CTD 24**



*To download brochure,
go to the webpage*

Go to webpage



Any customized size Very big size

We make ceiling trap doors of biggest sizes and deliver all over India; We make them as per customer sizes with minimum TAT

Unobtrusive

They have same finish as rest of ceiling and just a 2mm groove all around

Fast installation

They are very simple and fast to install

Safe & strong

They are engineered not to bend or warp and the shutters cannot fall down due to inbuilt locking

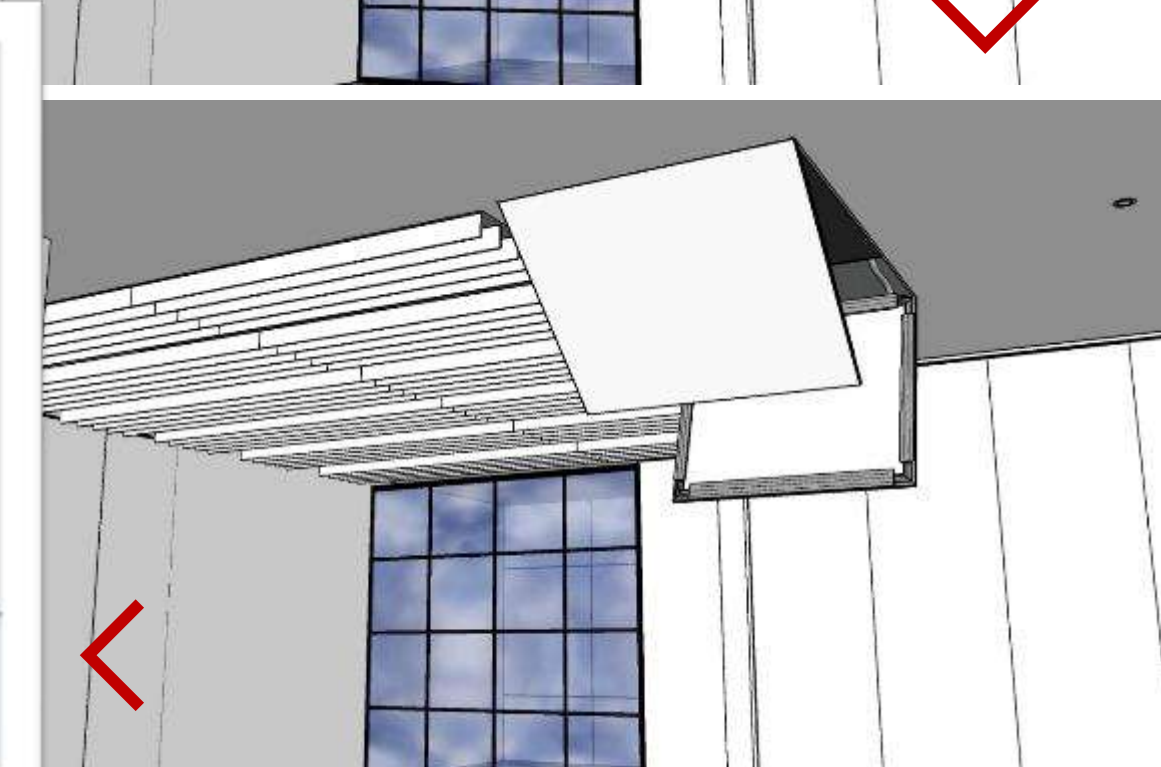
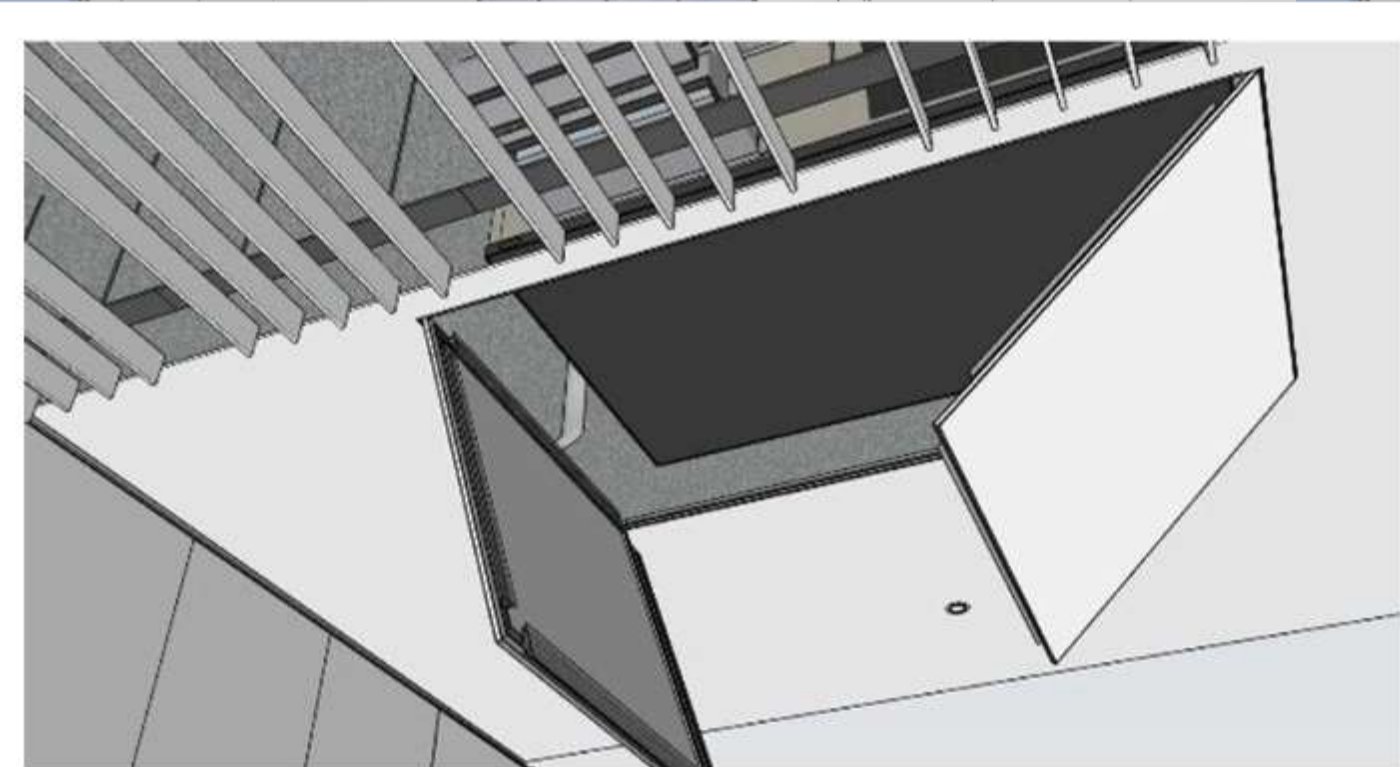
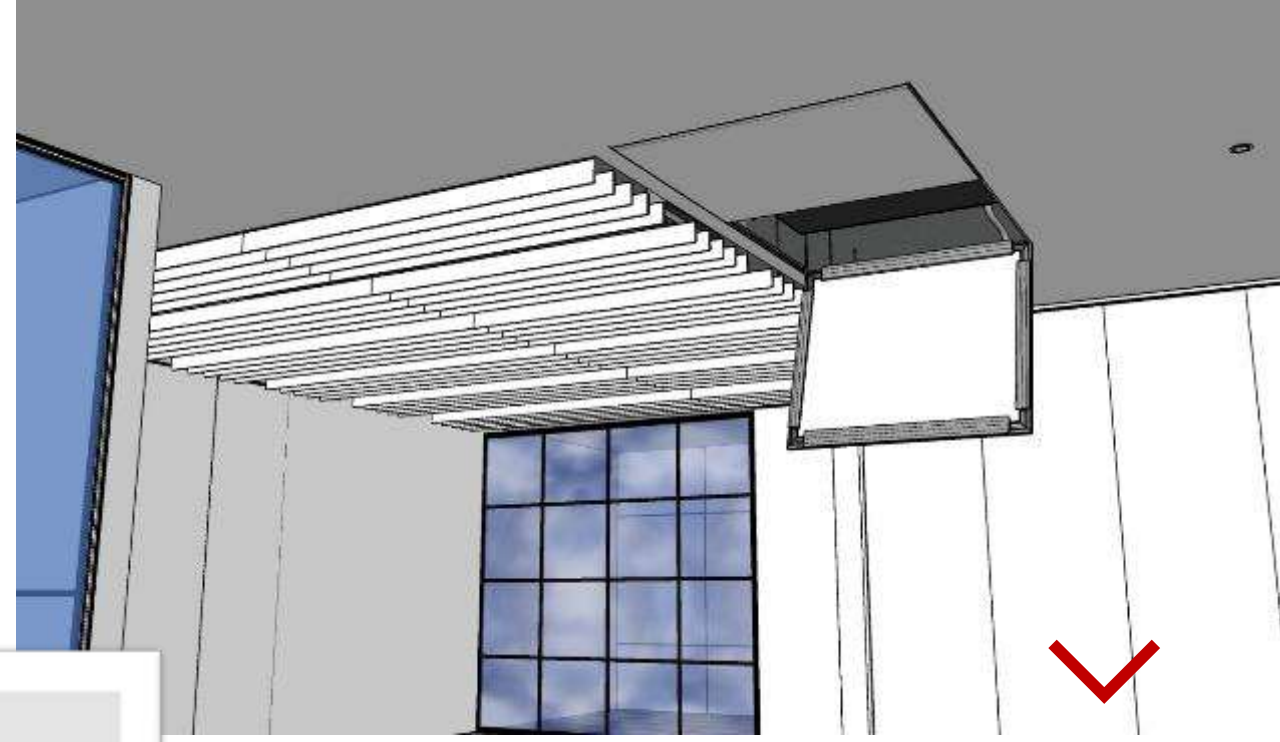
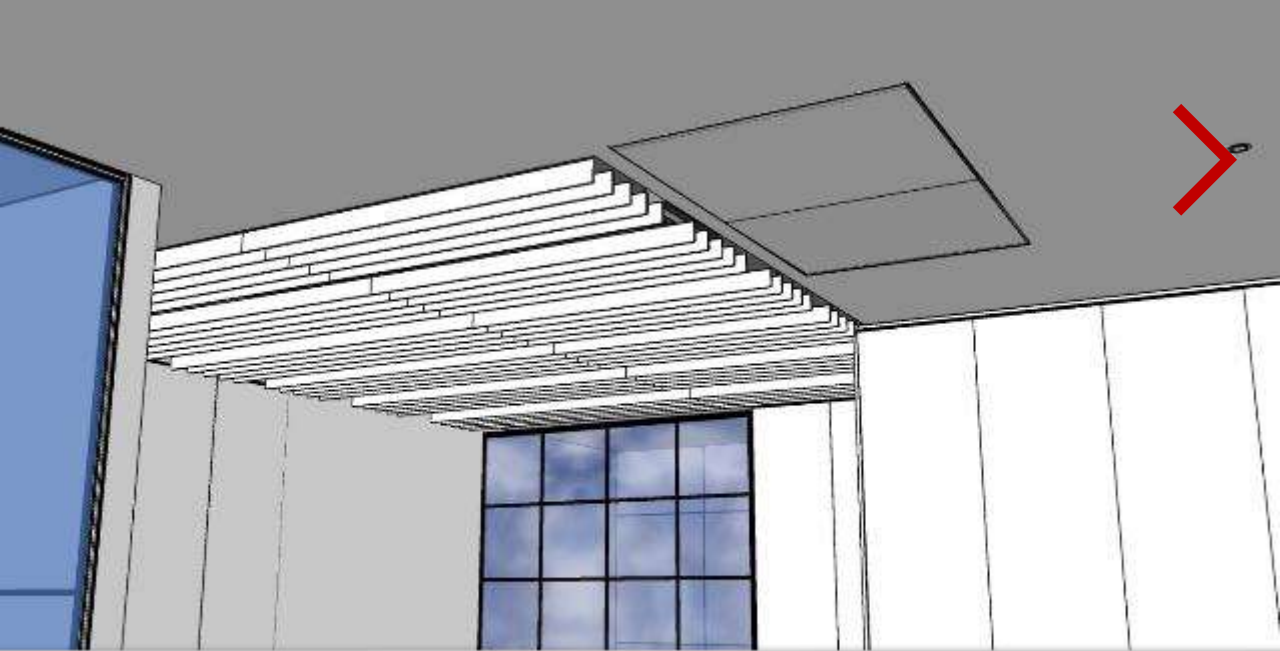

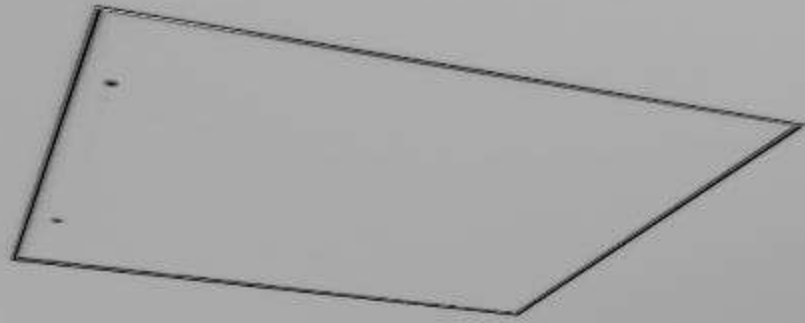

Just 2mm groove visible all around the shutters and frame

CTD 24



view from above ceiling side

CTD 23



Gypsum / MR board / Calcium silicate / laminate / ACP finish in shutter

CTD 23

- ✓ CTD 23 model with visible flange frame and shutters has proprietary and very strong hinge



CTD 24

✓ **Laminate finish with groove pattern virtually hides the actual grooves of the trapdoor**

CTD 24

Multiple shutter CTD

- ✓ **Very big size of Ceiling trapdoor**
- ✓ **Can be made and delivered in any custom size in very low time frame**



“ IQUBX ceiling trapdoors available in any size as per your requirement, even in big sizes, are very strong, sturdy, safe and cost-effective”

Ideally suited for

- ✓ **Residential units**, usually for above ceiling HVAC units and geysers etc in toilets – sourced by owners of apartments, farmhouses, bungalows, villas, residential units in towers (also by developers)
- ✓ **Offices (including coworking spaces)**
- ✓ **Hotels**, in all rooms and common spaces
- ✓ **Colleges, Hospitals, airports ... any other interiors**

Ceiling Trap Doors



**IQUBX
GREEN CERTIFIED**

BAFFLE CEILINGS

**BFC 1 BFC 2 BFC 12
BFC 3 BFC 4 BFC 5**



*To download brochure,
go to the webpage*

Go to webpage



Patent unique designs

Very unique designs not available any where in the world

Baffles with changeable unique finishes like lacquered glass, cork, veneer, printed vinyl, laminate etc

Cost effective Baffles with any height and high NRC value

Stackable modular baffles

Baffles in solid colours as well as wood finishes



BFC2 with LED lighting at intervals



BFC1 & 2 are patent applied



BFC1 & 2 double stacked with LED lighting and prelam board extensions

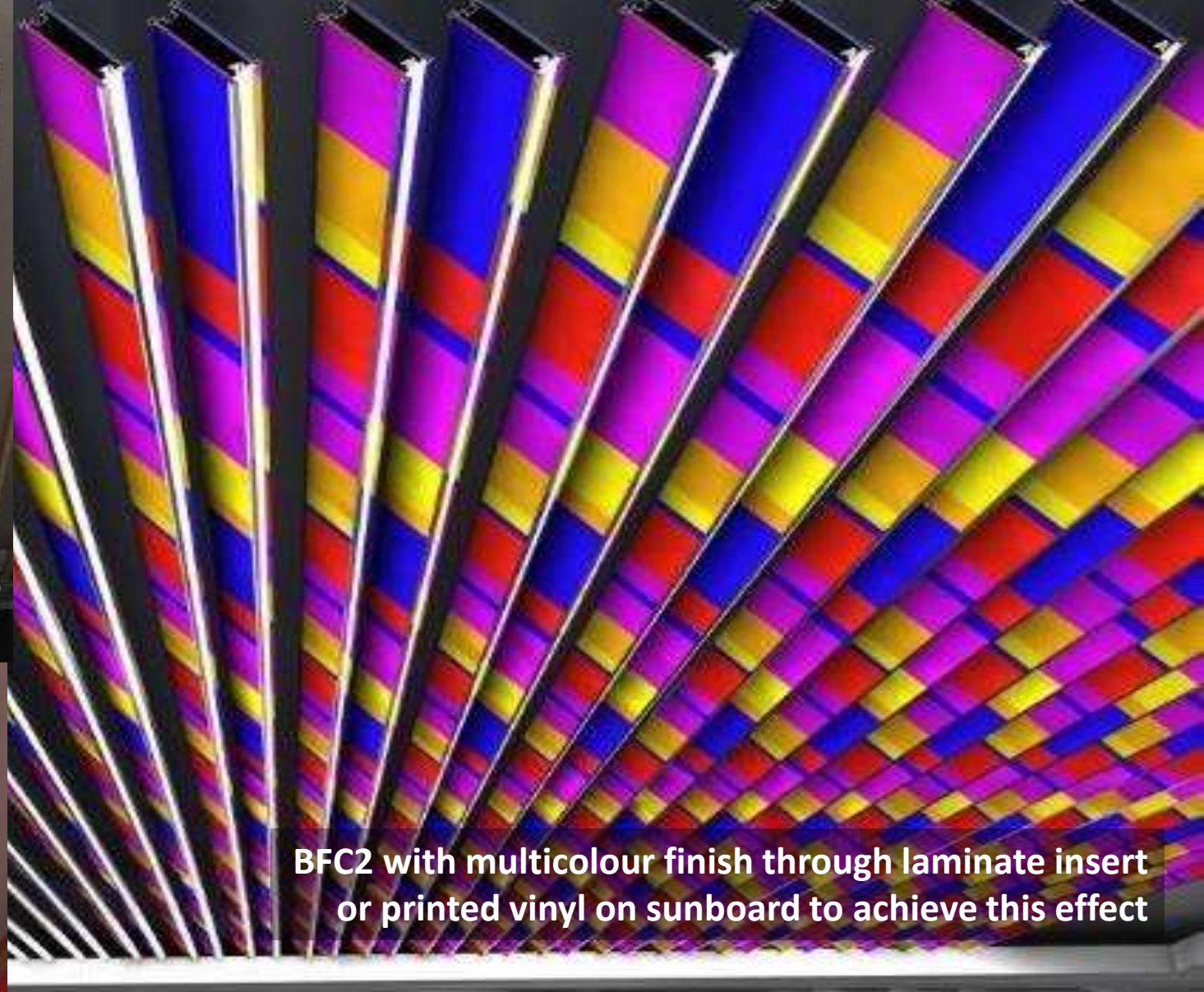

BFC2 with multicolour finish through laminate insert or printed vinyl on sunboard to achieve this effect

BFC 2 Modular Baffle 120 x 41.5 mm



BFC3 with mineral grid tiles, any height possible. This finish can be painted as well



BFC3 with cork finish, any height possible



BFC 3 Modular Baffle any ht. x 40 mm

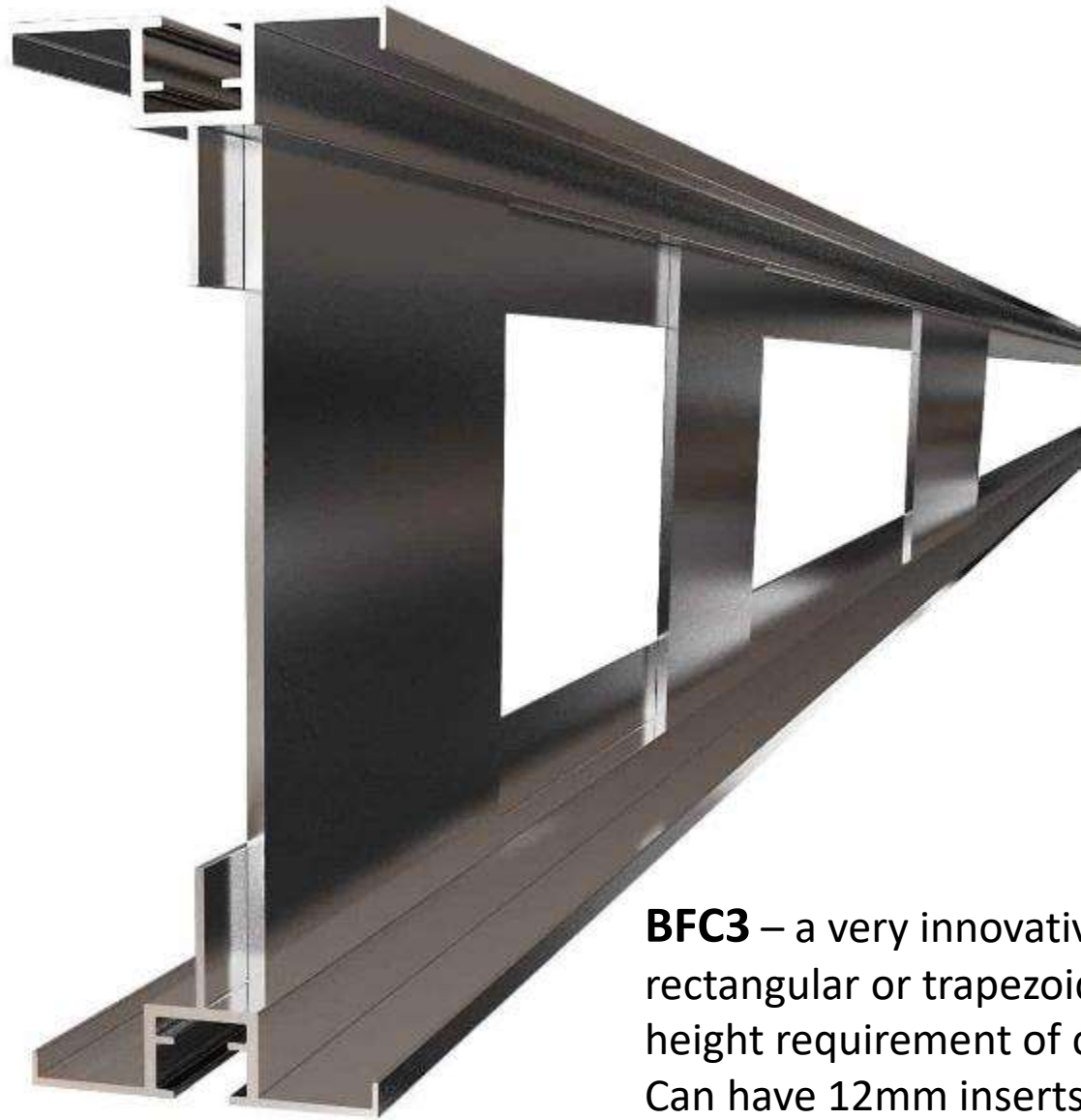

BFC3 – a very innovative and unique baffle with rectangular or trapezoidal chassis construction as per height requirement of client
Can have 12mm inserts like mineral tile, gypsum board, cork / veneer pasted on prelam / mdf

BFC3 – a very innovative and unique baffle with rectangular or trapezoidal chassis construction as per height requirement of client
Can have 12mm inserts like mineral tile, gypsum board, cork / veneer pasted on prelam / mdf





installation with
proprietary clips or
M5 bolts to subframe



100 x 25 mm

BFC 4



BFC4 – 100 x 25

An innovative application of mixed random colours

“ IQUBX baffle ceilings are very unique, innovative and patent applied systems – which offer flexibility in design expression and finishes”

Ideally suited for

- ✓ **Offices (including coworking spaces)**
- ✓ **Hotels**, in atrium and common spaces
- ✓ **Malls, food courts**
- ✓ **Colleges, Hospitals, airports**
- ✓ **Stilt spaces of residential towers**

Baffle Ceilings



IQUBX
GREEN CERTIFIED

TABLE LEG
FRAMES

FOR WORKSTATIONS
WSL01 WSLT50



*To download brochure,
go to the webpage*

Go to webpage



Transformer

DIY kit completely assemblable on site,
with changeable configuration from
shared to nonshared, single to double
etc as per requirement

Unique design

Unique contemporary sleek design

Fast installation

Highly engineered sections and joinery
can reduce time of installation by half



WSLT50 series

**WSL01 & WSLT50 series
Modular Workstation
Table Leg Frames**



WSL01 series





**WSL01 series
Modular Workstation Table Leg Frames**

100% aluminium
highly modular
flexible sizing
quick delivery
strong & durable
Green certified



WSL01F6001 for single nonshared ws for 1 people
WSL01F12001 for single shared ws for 2 people

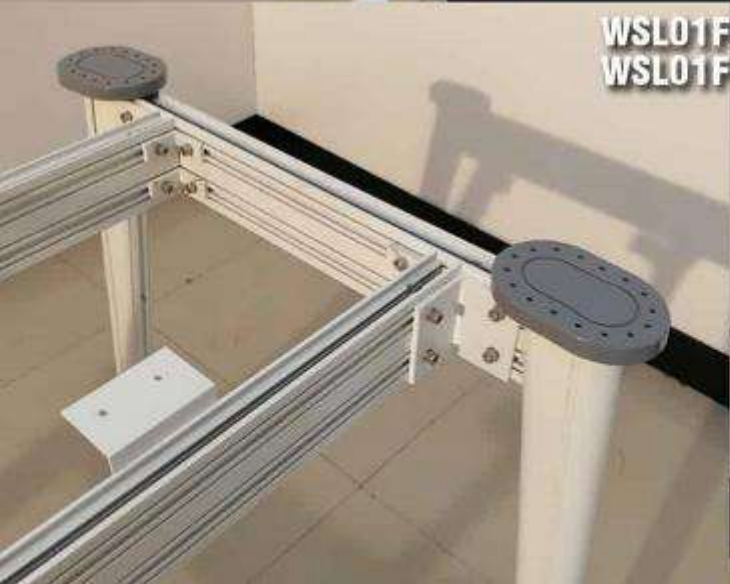



Aluminium Modular Workstation Leg system







**IQUBX
GREEN CERTIFIED**

FLOOR JUNCTION BOX

JB 22 JB 23



[Click here to
Watch
product
video](#)

*To download brochure,
go to the webpage*

[Go to webpage](#)



Patent design

Unique solution for every project, can be provided in any shape and size, hinges & wire manager optional

Same floor finish

Lid design accommodates same floor finish like stone, tile, carpet, wood for beautiful interior

Safe strong hygienic

Lid design doesn't come loose like old fashioned ugly plates which can hurt. Prevents entry of dust & rodents

Can be retrofitted

Can be retrofitted in old MS or GI floor junction boxes any time



WHY?

GI Floor Junction Box are not good enough !



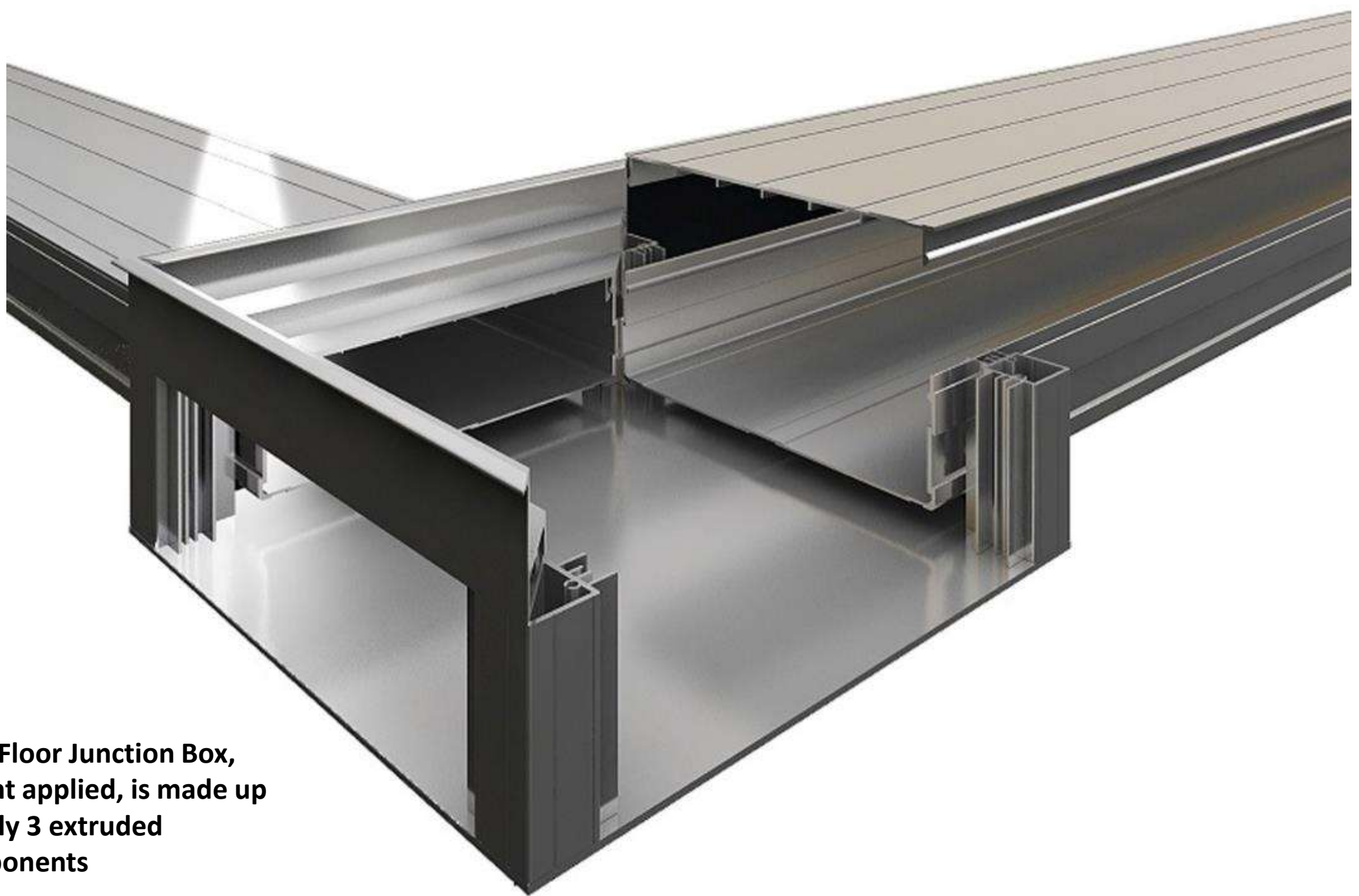

**JB22 Floor Junction Box,
patent applied, is made up
of only 3 extruded
components**



kota stone insert in JB022 lid

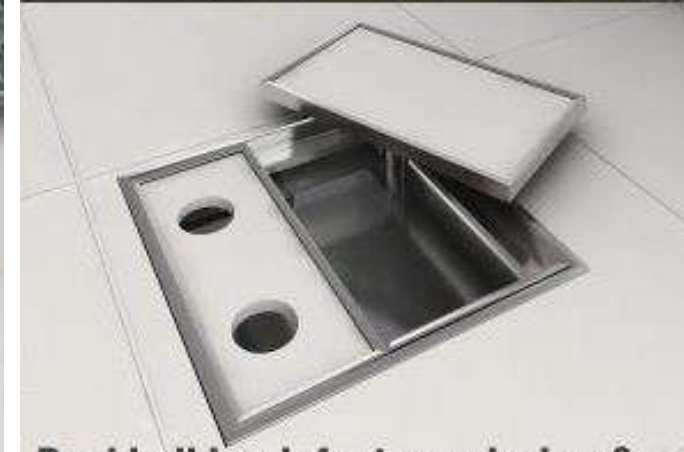

Double lid or infact any design & shape possible as per requirement



Seam less, clean, aesthetic flooring for a contemporary interior

Unobstructed floor finish with high load capacity, doesn't squeak or creak



**Recyclable
Green Building Material
Ideal for LEED Projects**



Lid in cavity doesn't come loose, thus, no entry of dust, mites, bugs, rodents which may damage the wires and cause disease



OVER HENRIE

**No loose covers means
no accidents
no tripping**



Most economical solution as no wastage and can be self fabricated on site

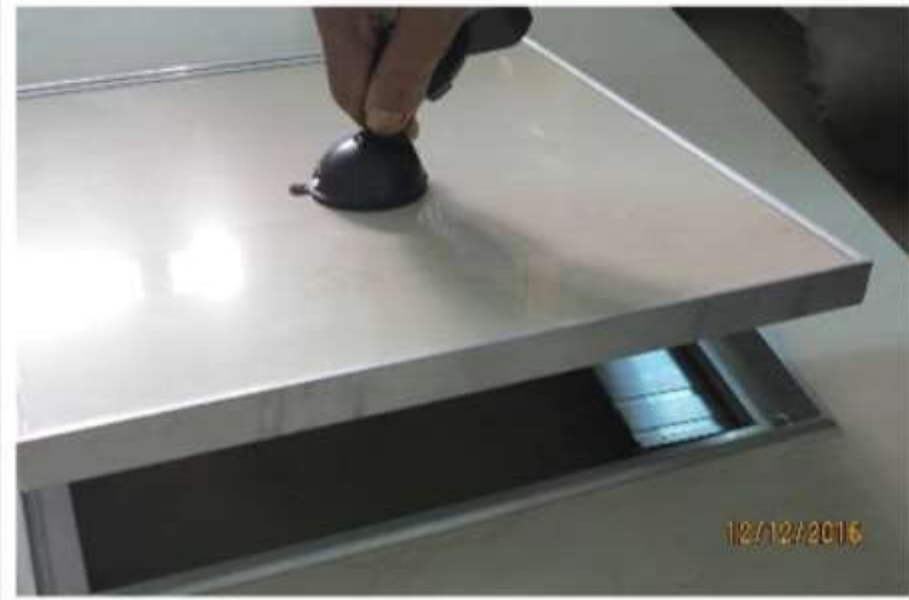

JB22 / 23 Floor Junction Box,
with wood plank, carpet and
tile embedded in lid

Modular Floor Junction Boxes



IQUBX
GREEN CERTIFIED

FLOOR BOX

FB 01 FB 02

*To download brochure,
go to the webpage*

Go to webpage



Modular design

FB01 is World's first multi bay modular design can be provided in any number of bays and any length.

FB02 can accommodate floor finish and is based on floor junction box JB23 with 95mm depth and can be made into any length in 1 or 2 bays

Thinnest design

FB01 is just 55 mm thin and can be installed in any floor finish

Can be retrofitted

Can be retrofitted in old floor boxes which break easily



**IQUBX FB01
ELECTRICAL
FLOOR BOX OUTLET
55mm deep**





LV sockets are fixed in a specially designed module

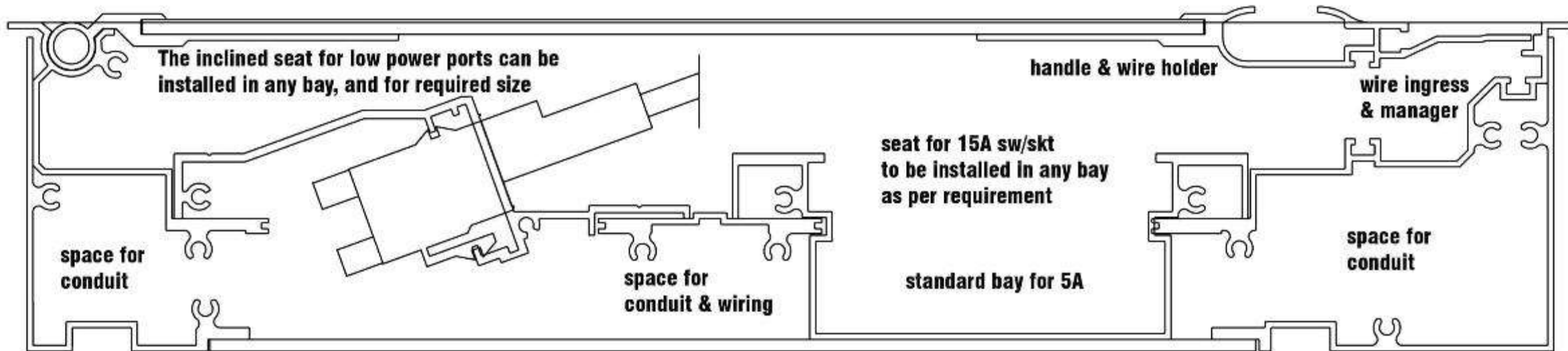

IQUBX FB01 electrical floor box outlet - 2 bay section

unique two side wire manager with integrated handles for maximum ease of functionality



FB02



Lid can accommodate any finish upto 10mm like tile, carpet etc



The switch socket bay can be swivelled open for wiring



**IQUBX
GREEN CERTIFIED**

CABLE RACEWAY

RW011 150X45

Modular design

World's first professionally designed raceways which are stackable horizontally in multiples of 150 mm; designed to fit snug in substrate

Snap fit lid

Snap fit lid makes it easy to install, even exposed to floor finish, strong enough to carry good load

Can be retrofitted

Can be retrofitted in any interiors to carry cables across without complete floor dismantling

*To download brochure,
go to the webpage*

[Go to webpage](#)





WHY IQUBX Floor Raceways for contemporary interiors?



Recyclable  **Green Building Material**
Ideal for LEED Projects

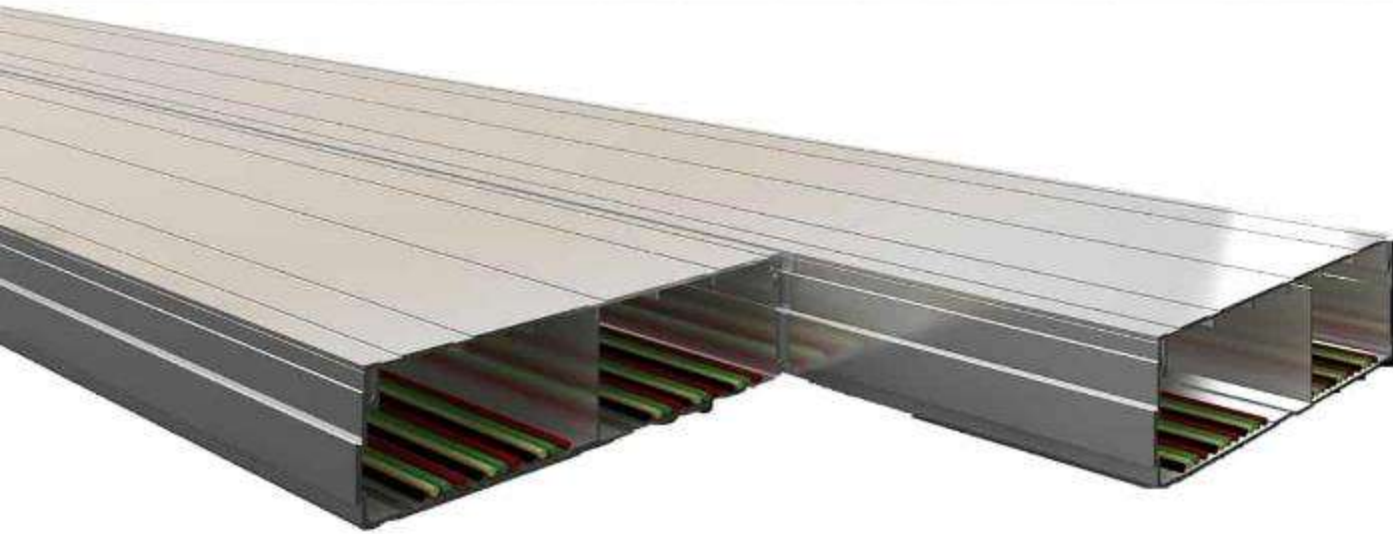

Extruded profile fins can take heavy load and does not allow lid to sag

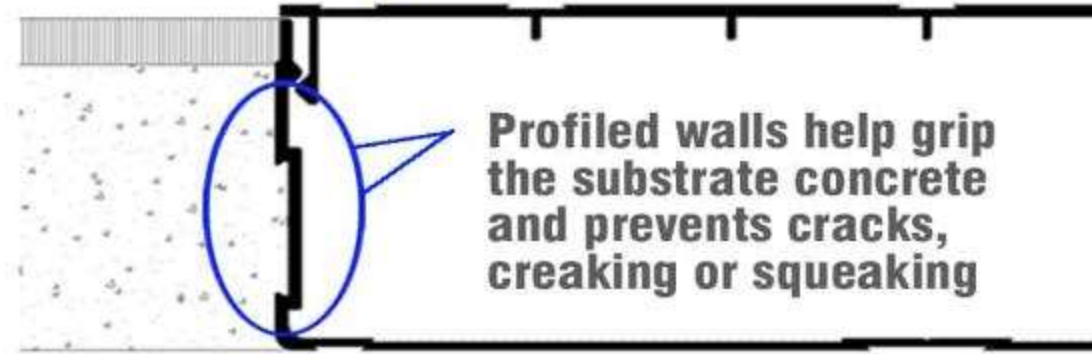

Profiled walls help grip the substrate concrete and prevents cracks, creaking or squeaking



Can be laid exposed on floors in office and commercial interiors with excellent finish and load bearing capacity

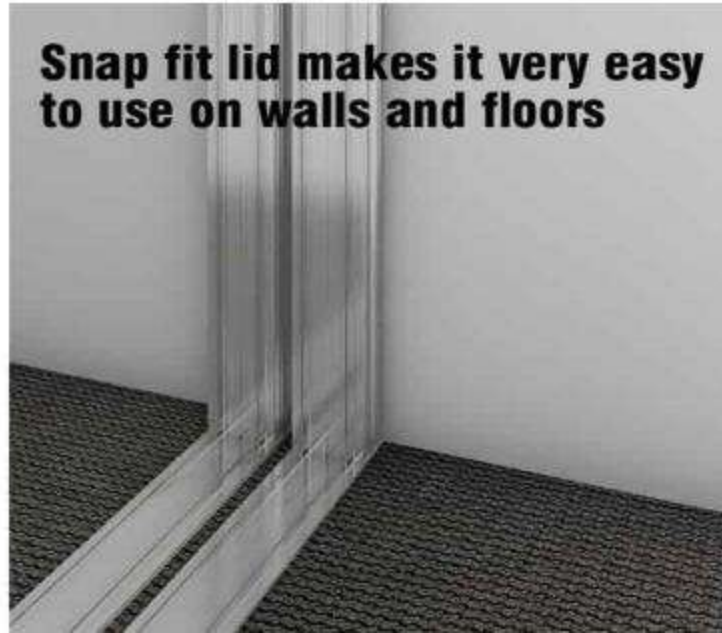

Snap fit lid makes it very easy to use on walls and floors

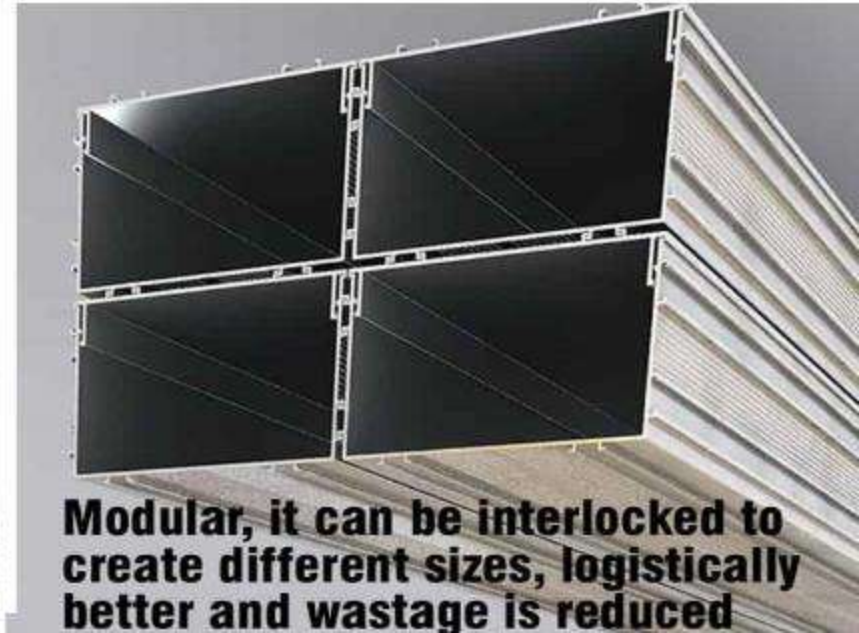

Modular, it can be interlocked to create different sizes, logistically better and wastage is reduced

trendy

Unique modular, stackable in multiple width, aluminium floor trunking cable raceway with snap-fit cover lid can take high loads without sagging.

For electrical & data wiring & cables

**EXPOSED in-floor
& on-floor Raceways**

for better wire management and contemporary aesthetics



IQUBX RW011 FLOOR RACEWAY





**IQUBX
GREEN CERTIFIED**

SKIRTING BOARD 100, 75, 50 MM HIGH

CORNER GUARD 22 X 22 MM

TRANSITION PROFILE 32 MM

*To download brochure,
go to the webpage*

[Go to webpage](#)



IQUBX SK031CR ALUMINIUM CHAIR RAIL

SK50 and SK75 are 50mm and 75mm high, and need to be fixed with screws on which gasket covers

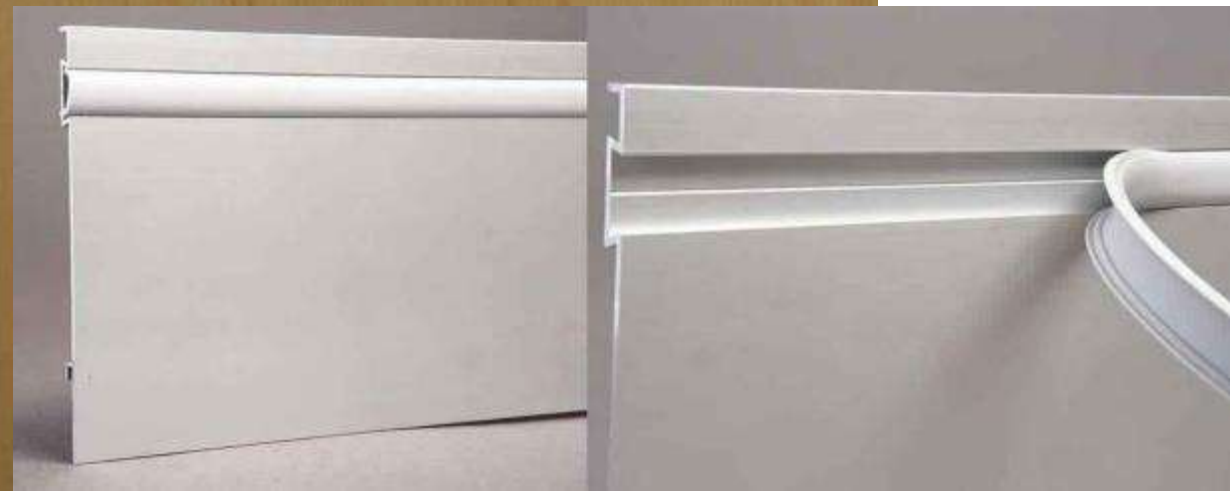

IQUBX SK031 ALUMINIUM SKIRTING BOARD





SK100 is unique 100 mm high, single component skirting board which can be snap fit mounted on cuttings from waste fixed on wall in reverse



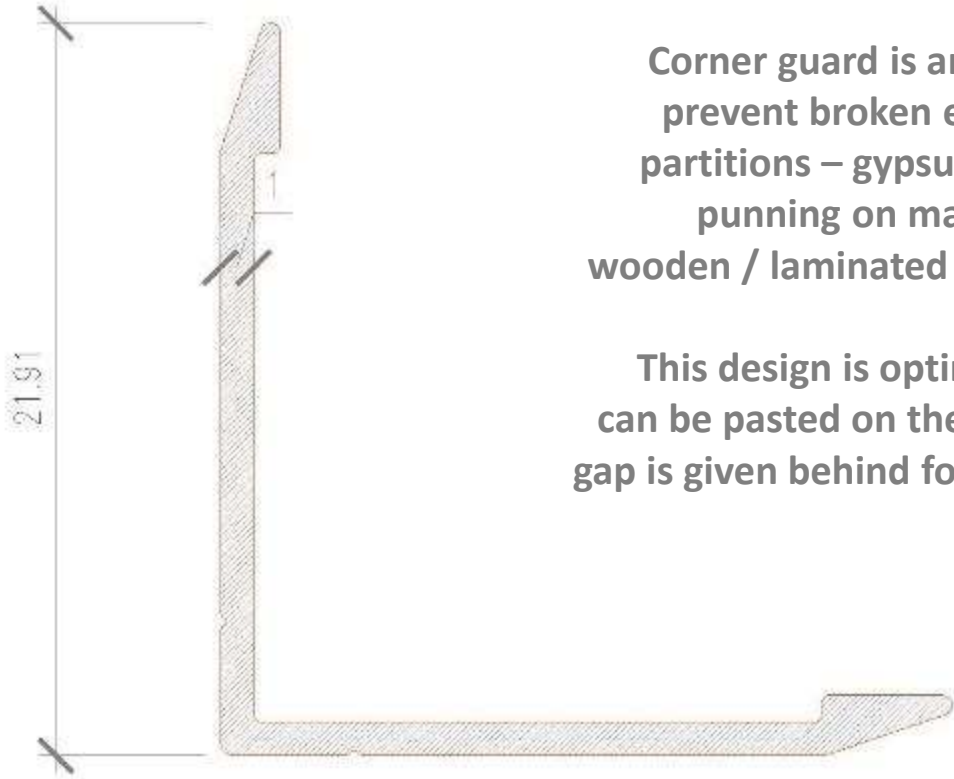

Corner guard is an ideal solution to prevent broken edges of walls and partitions – gypsum partitions, POP punning on masonry walls, tiles, wooden / laminated board corners etc

This design is optimized for size and can be pasted on the corner for which gap is given behind for adhesive to stay

**IQUBX
GREEN CERTIFIED**

CORNER GUARD 22 X 22 MM



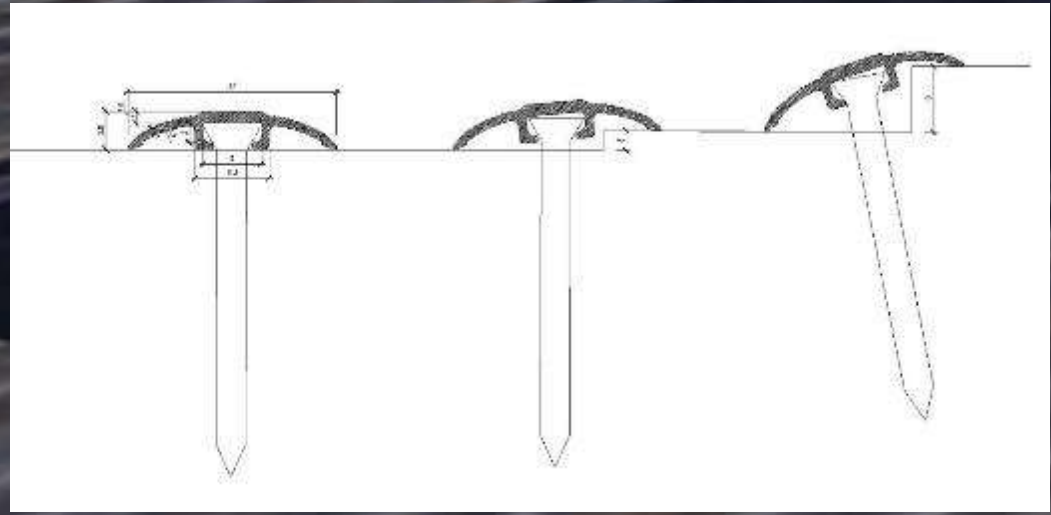

Fixable to take a floor level difference upto 10 mm

**IQUBX GREEN CERTIFIED
TRANSITION PROFILE FT01**

32 MM



IQUBX GREEN CERTIFIED T PROFILE

8.5 X 8.25 MM

Iqubx T profile is a moulding cover for joints, with front face of 8.5 mm and a groove of 1.25 mm.



Customized Solutions

IQUBX offers **customized interior systems solutions as per customer requirements** and delivers by adapting their sophisticated modular systems to the customer requirements



Willing to design and deliver completely new systems in a very short TAT of just couple of months

This is a unique positioning not offered in the country as it is a difficult proposition without the flexible and innovative design & manufacturing strategies adopted by us



Main components of the assembly

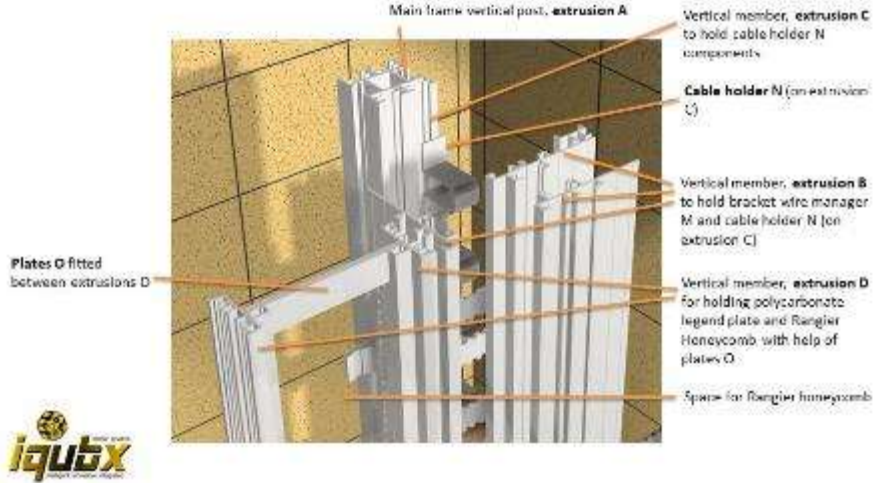

Main components of the assembly

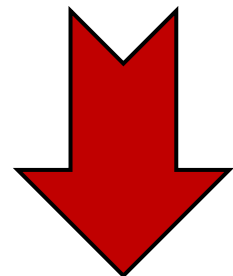
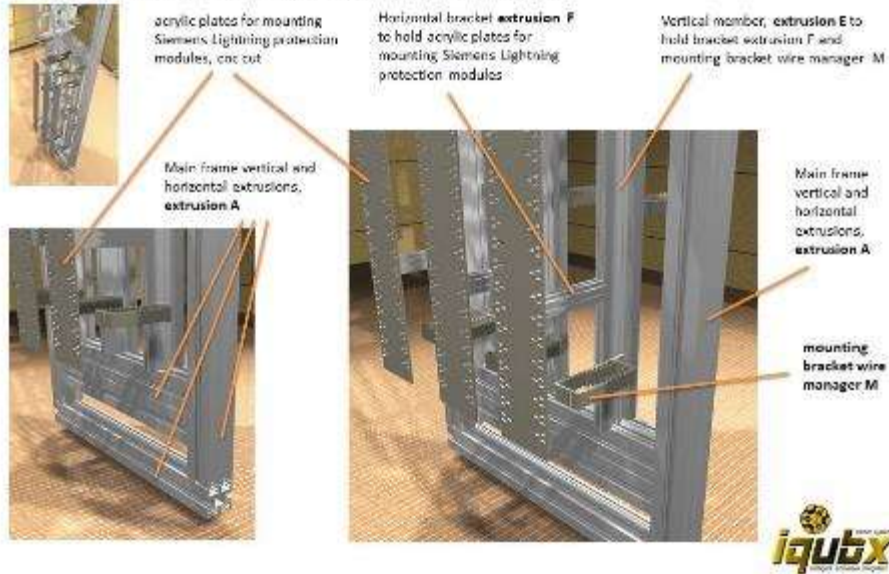

Siemens CTR-CDR

For

Delhi Metro Import substitute

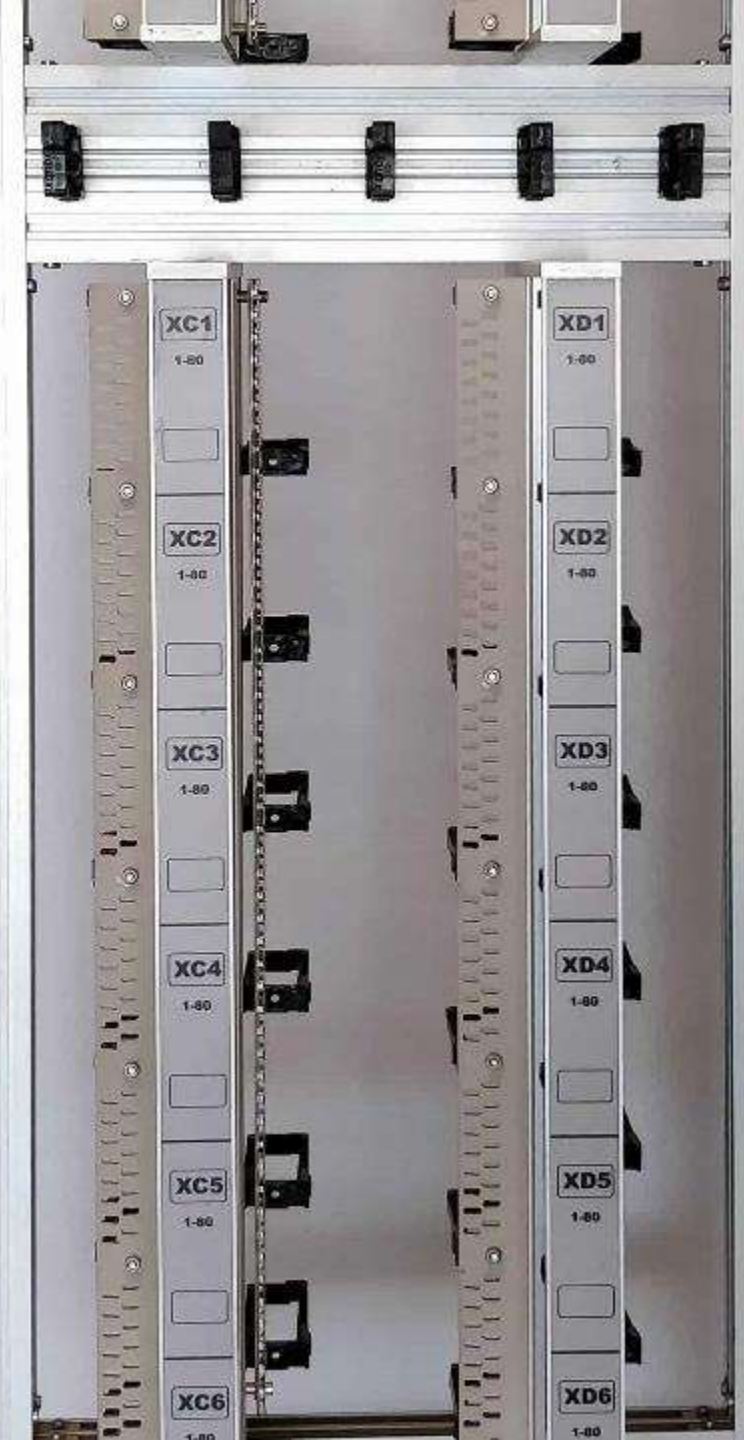
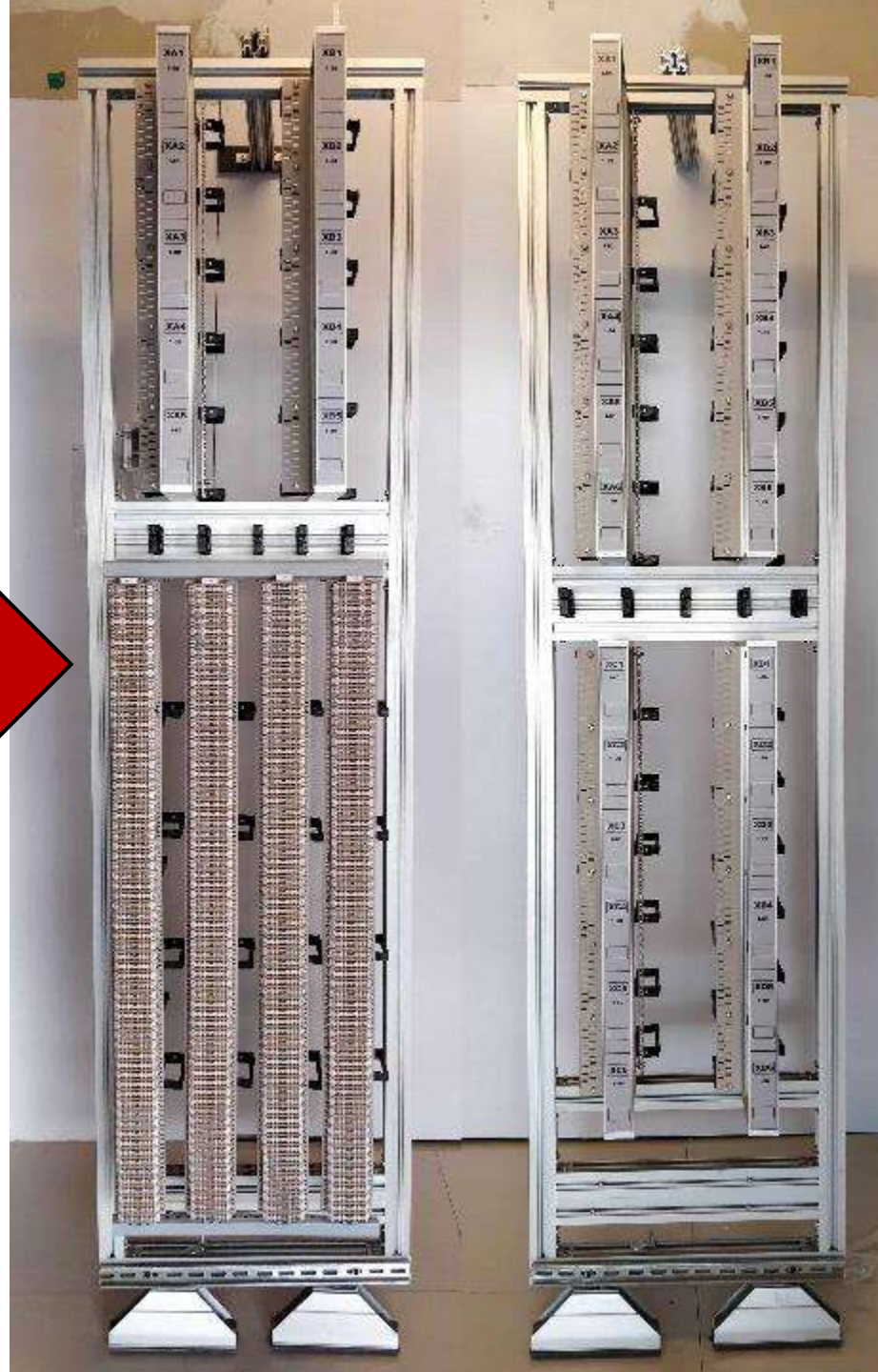
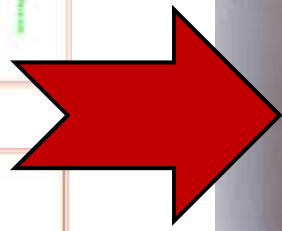
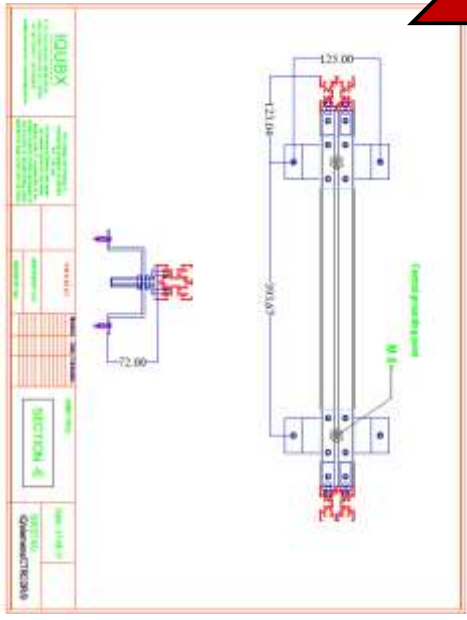
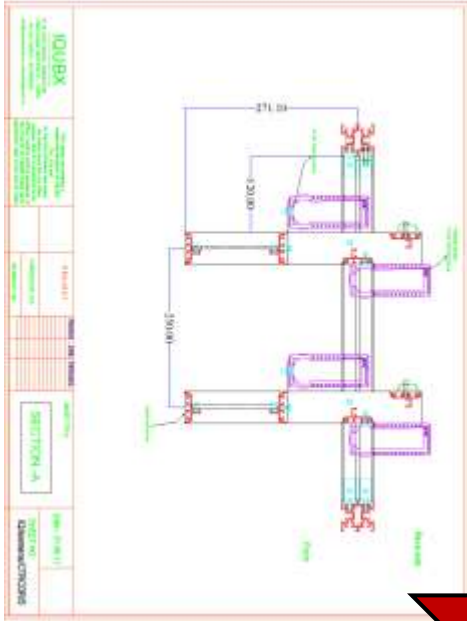



GMR
Hyderabad
airport
80' x 25'
partition

Our Clients

Sr.No.	Client	Client Company Name	Product Name
1	Mr. Ash Jain	Design concepts	CP1000
2	Mr. Vivek	III7	CTD04
3	Mr. Suresh Choudhary	Roo Polymer	CP2012,DF01,GD02
4	Mr. Deep Nair	OPT9 LTD	MR 100
5	Mr. Manish Ranjan Mishra	Tran Culture	CP1000,WP01P,DF01,GD02
6	Mr. Man	Dynaka Bio-Style	CTD04
7	Mr. Karish	Jaskart Chemicals	CTD04
8	Mr. Deep	Malaral Centre	CTD04
9	Mr. Karishk Hatter	Mr. Karishk Technology Ltd	CTD04
10	Dr. Prashant Jindal	NYS SkinCare Dental Care Ramnasha	CTD04
11	Mr. Sandeep Sharma	GST INTERIORS	MR01
12	Mr. Vinod Gupta	MS. Smita By Interiors Solutions India Pvt. Ltd.	CTD04
13	Mr. Tushar Gang	F D Model Craft	CP2012,DF01,GD02
14	Mr. Cassio George	Synoptic Systems India Pvt Ltd	MR02
15	Mr. Harish Aggarwal	Parthen Media Solutions	MR010
16	Mr. Dhanraj	Carteado	MR011
17	Mr. Harvey Gupta	IDC	MR001
18	Mr. Kamal Duban	Shadhin Ventures Pvt. Ltd	MR002
19	Mr. Ananda	Nimansa Ltd	CTD04
20	Mr. Abhishek Vikram Rawat	Talks per. Ed. Madhya	MR03



Aditya Birla Finance
Home Loans



Soka Gakkai
International



FAIRFEST



DCB BANK



CULTMODE

LUMAX



TENDRIL INTERIORS PVT. LTD.

Google search engine

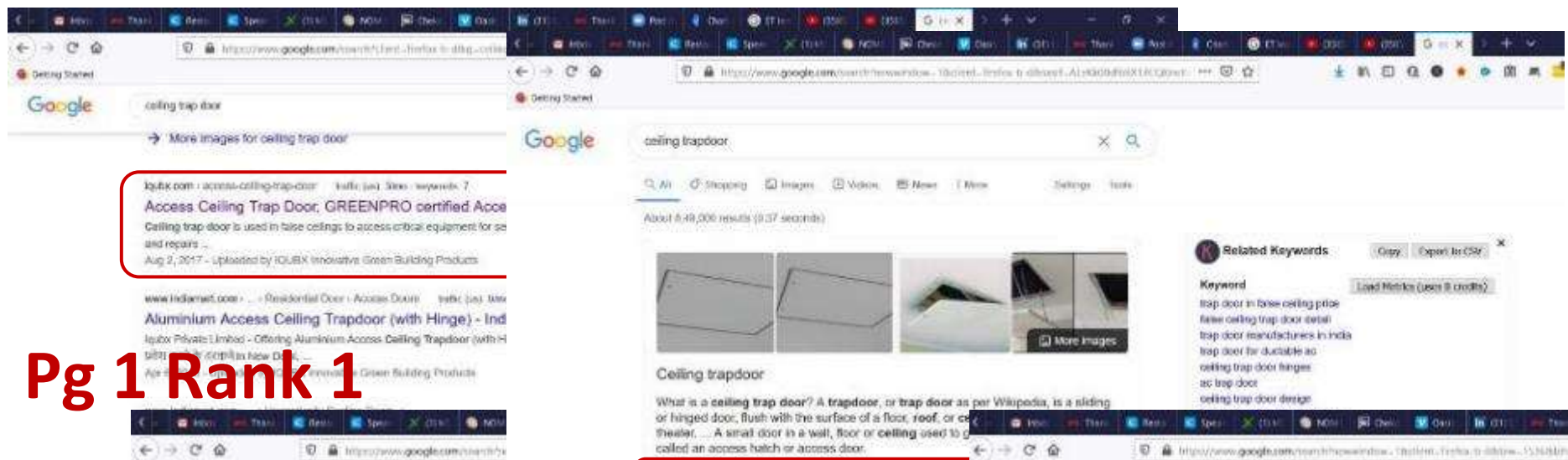

Pg 1 Rank 1

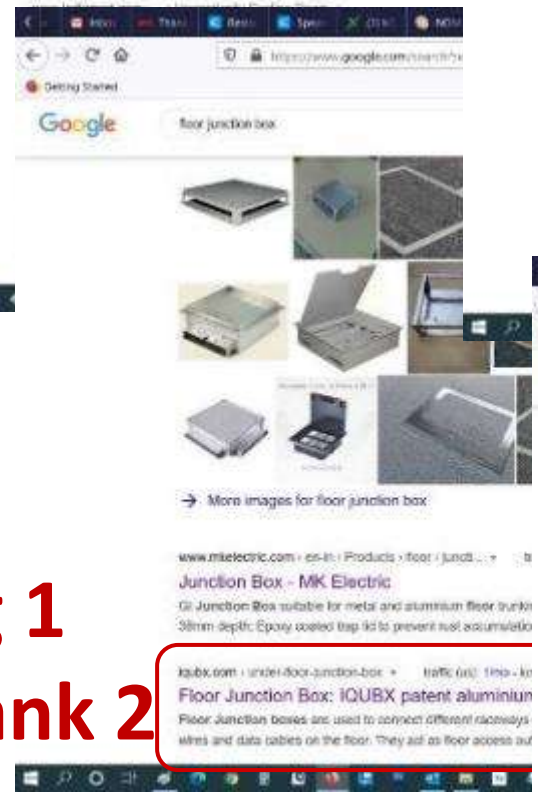

Pg 1 Rank 2



Pg 1 Rank 1

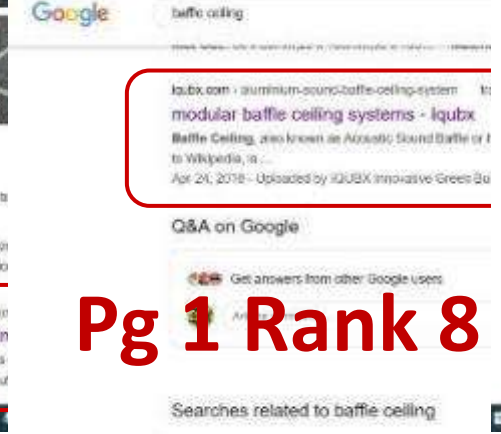

Pg 1 Rank 8

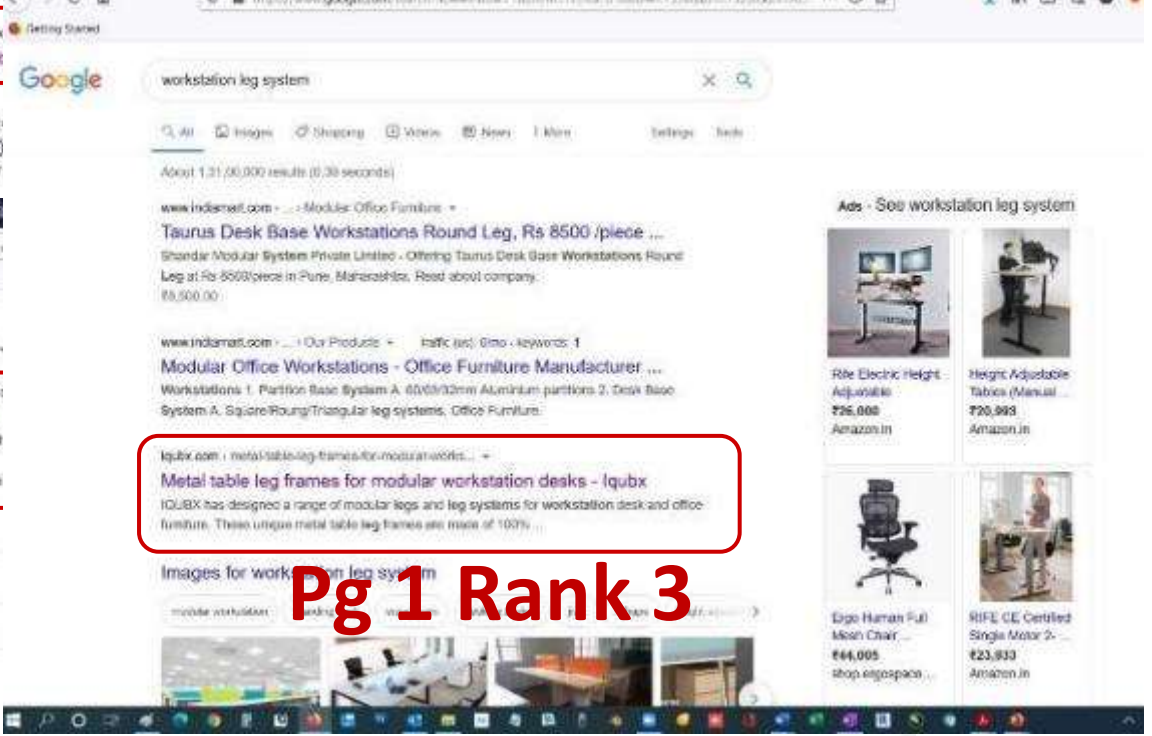

Pg 1 Rank 3

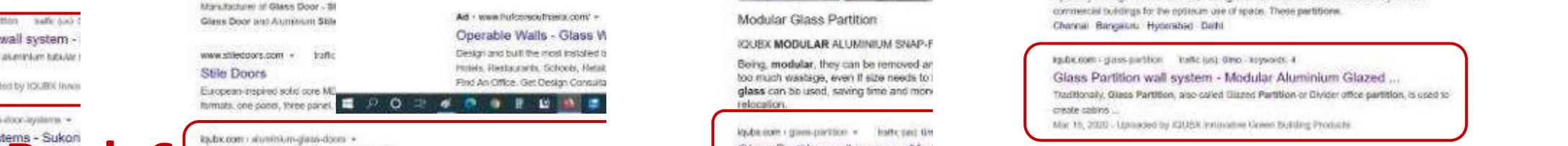
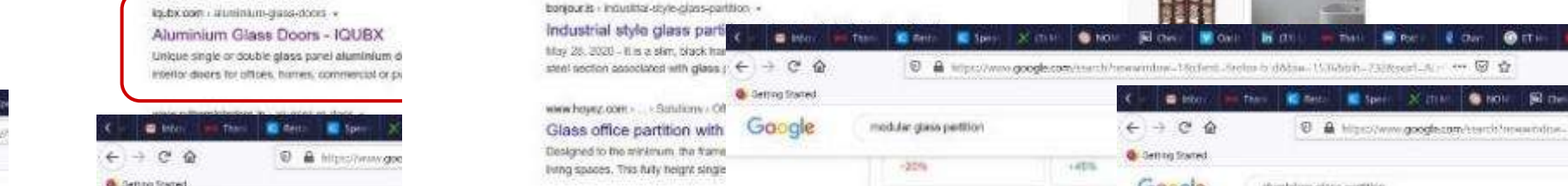
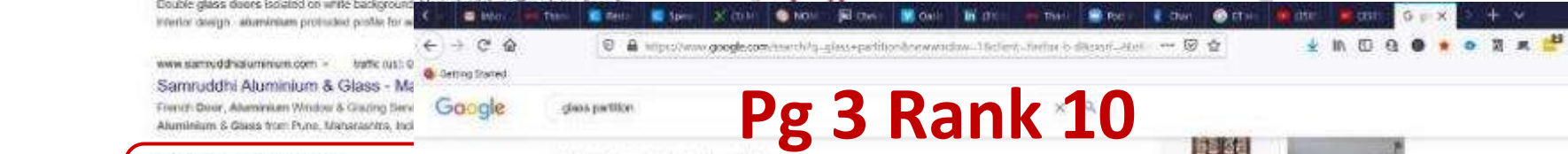
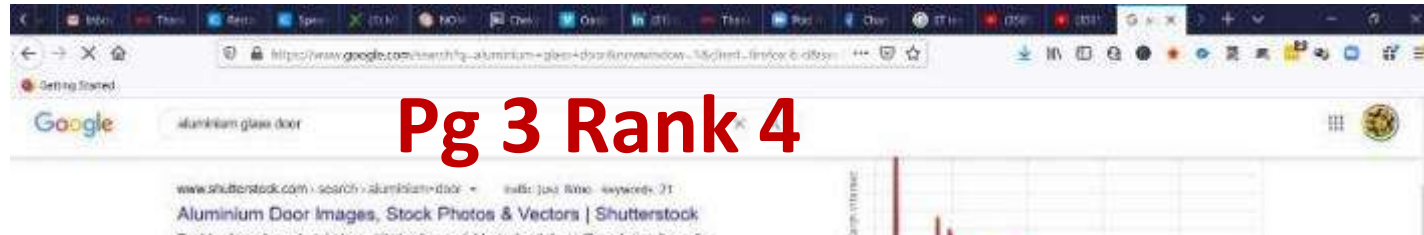

Google search engine



Search

- Home
- My Network
- Jobs
- Messaging

11-Month PG Program - Become a Data Scientist without programming knowledge.

Messaging

godrej

Sanjiv Save Aug 21
You: with your kind of background and experience, I...

Ruchi Singh Aug 21
You: Hi IQUBX- LARGEST NUMBER OF GREEN CERTIFIED...

Godrej Green Buildi... Aug 21
You: Hi IQUBX- LARGEST NUMBER OF GREEN CERTIFIED...

Sanjiv Save • 22m ago
IQUBX Green Modular Interior Systems is the ET Emerging Consumer Brand of the year - IQUBX
iqubx.com • 3 min read

Sanjiv Save • 2:21 PM
👍

Sanjiv Save • 2:26 PM
Great work amit i was working as business intelligence chief in GODREJ PROPERTIES and now a CEO in MYNT a furniture company but never seen a product like urs. Great

“ I like the very different IQUBX products



I like the very different products of IQUBX and want to use most of them for my projects. I have used ceiling trapdoor CTD24, which are excellent in design

and... [Read More](#)

Irfan Shaikh
Nebula infraspace LLP



Joby Thomas • 11:26 PM

Dear Amit, Thankyou for your time today, I really appreciate your concept, process, and products. I am sure we have a big market in the region. Looking forward to a fruitful collaboration. This is my e mail ID and will include my partner also in the next meeting and the mails.
jobykt@hotmail.com

Hi Amit,
As discussed we have used your IQUBX profiles for both the partitions and the workstation legs and find them to be of **good quality**, and allows us the versatility to **configure permutations and combinations of workstation layouts**. We are now planning to introduce these systems in to our catalogue range and offer it as a complete solution to our clients. We and look forward to and long and mutually beneficial working relationship with IQUBX.
Regards



Harvey Lopez
Project Management Director

Testimonials

Sat, 29 Aug 2020 16:16:22 +0530 amitsharmacs1975@gmail.com wrote

Dear Sir,

We have got trap doors installed for our Centralised AC for our residential building in Gurugram, Haryana. The first point of contact was Mr. Sumit from IQUBX. We have got truly professional service from him. **The product quality is excellent and they deliver what they promised. The trap door is light weight and completely matched with our ceiling.**

Thanks IQUBX.

Regards,

Amit Sharma

karan.razdan@skvindia.com

Hi,

We, as a company are one of the leading Design and build commercial Interior fitout company. Furniture and fixtures are one of the most important elements in any and every project that we do. We came across Amit and Iqubx while searching for economical yet sustainable modular partitions solution for our project.

I say this with delight that Amit and team have done a splendid job in providing a perfect modular partition solution. The product is one of the best modular systems available in the market highlighting and covering the gaps in the existing systems.

I wish Amit and team all the very best for their future endeavours.

Keep shining!

Best regards,

Kunal Trehan

Business Head - Furniture division

SKV

Wed, 02 Sep 2020 3:52:48 PM +0530

IQUBX offers unique and green certified products for all interior solutions. Mr. Amit himself being an architect has recognised the gap between what's available in the market and what architects and interior designers actually need. All the products are highly customisable which is a boon for all designers. Mr. Amit puts in time and effort to understand project requirements and gives the best possible solutions which are structurally sound as well as aesthetically pleasing. This cannot be said about other Indian products available in the market. I look forward to working with him and his team in the future!

Sincerely,

Shweta Shah

studio | pomegranate

Sat, 29 Aug 2020 6:46:51 pm +0530

alocjain@gmail.com wrote

i had been looking for the clean, international look for my aluminum and glass partitions but could not seem to get proper solutions even after trying multiple markets and vendors, till i reached out to iqubx.. their sections are sleek and unconventional, their push fit beadings click effortlessly in place and generate a crisp, clean, minimalistic mies van der rohe kind of corporate look in my office interiors.

for ARCHITUDE

aloc jain

Architect

Team



Amit Garg B.Arch, M.Arch, Founder Director

Nationality & Citizenship: Indian

Education: B.Arch, M.Arch, from prestigious **School of Planning and Architecture, New Delhi**

Experience: **25 years of experience** in Architecture, interiors, graphics, exhibitions and product design

Achievements: He is a conceptualizer and innovator + inventor, with **3 applied patents** to his name, and designer of 100s of innovative interior systems. He was shortlisted as **Economic Times Leaders of Tomorrow** finalist for North zone this year. He is invited as a speaker on various platforms.

Role in IQUBX: Founder Director, 99% share holding, Heads the design team, Develops and coordinates strategies for production and business development





Call us for any inquiries
Please connect on linkedin
Like our facebook page
Visit our website

9811204811

9999001967

amit@iqubx.com

www.linkedin.com/in/amitgarg-iqubx

<https://www.facebook.com/iqubx/>

www.iqubx.com