

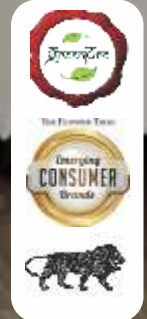

LARGEST NUMBER OF
GREEN CERTIFIED
MODULAR FURNITURE &
INTERIOR SYSTEMS IN INDIA



All copyrights, trademarks, Intellectual property rights, patents reserved in name of IQUBX pvt ltd and its directors. Any copying of logo, images, designs, product designs without explicit written permission of the directors of IQUBX pvt ltd shall be a punishable offence. All the product designs are IPK protected

FLOOR TRUNKING SYSTEM

www.iqubx.com



FLOOR JUNCTION BOX

JB022
JB022L
JB022D
JB022H
JB023
JB023L
JB023D
JB023H

FLOOR BOX

FB01
FB02

FLOOR RACEWAY

RW011
RW033

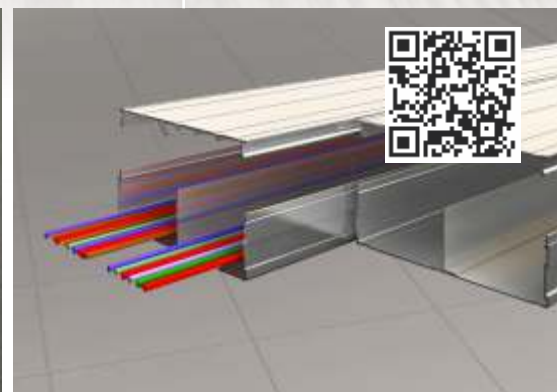



THEY HAVE BEEN DESIGNED TO ACCOMODATE FLOOR FINISHES INCLUDING STONE, TILES, WOOD, CARPET, VINYL ...

IQUBX FLOOR JUNCTION BOX IS SUITED FOR HIGH TRAFFIC ZONES LIKE OFFICES, AIRPORTS, RAILAY STATIONS, UNIVERSITIES AS WELL AS RESIDENTIAL INTERIORS





patent applied, fully flexible, strong floor junction box with upto 20mm floor finish in lid, ht. adjustable



- JB022 Lay-in lid type aluminium junction box
- JB022L Lay-in type lid and outer frame without legs to retrofit in existing MS / GI floor junction boxes
- JB022D Lay-in DOUBLE lid type aluminium junction box
- JB022H Lay-in lid HINGED type aluminium junction box

QUBX JB022 is **patented** Aluminium Modular under floor junction box for wire management, **certified GREENPRO (by IGBC, CII)**. It is available in **any required size, customizable** and delivered in no time.

This Aluminium junction box fits excellently in the cavity, covering the floor cavity from inside as well as matching the top surface of the floor, giving a professional aesthetic finish inside and outside the junction box.

The lay-in lid type design has many advantages.

Best advantage is that the lid has a collar depth of 30mm to accommodate various floor finishes including 18 mm stone, 10mm tile or carpet, thus giving a seamless floor. It can also be powder coated in shade and colour to emulate the flooring material, making it completely unobtrusive.

The Lid cover sits in the cavity of the floor junction box, without using any fasteners or screws for fixing. Thus, it **does not come loose marring the aesthetics**, while it can be easily lifted whenever necessary. This prevents entry of dust, rodents and other external elements. It also prevents safety hazards of people tripping over loose cover plates.

JB022L model with lid and outer frame only (without legs and bottom plate) can be retrofitted in most of existing MS/GI floor junction boxes.

These floor junction boxes are ideal for locations such as in office spaces, hotels, showrooms, hospitals, institutes, educational institutes/universities, airports, industries, and others, like commercial establishments.

Technical Data

- Any length and width
- Minimum height 50mm to any ht.
- Lid collar depth 30mm, can accommodate any floor finish upto 18 mm like stone, tile, carpet, wood
- JB022a, outer channel – 32 x 20.5 mm
- JB022b, inner channel – 32 x 39 mm
- JB022c, legs channel – 28 x 28 mm

Raw mill finish, can be powder coated in any color or anodized

GREENPRO certified 6063 aluminium alloy, 100% recycled aluminium - 10% pre- consumer & 90% post-consumer



 Recyclable certified **Green Building Material** Ideal for LEED Projects



Lid in cavity doesn't come loose, thus, no entry of dust, mites, bugs, rodents which may damage the wires and cause disease



No loose covers means **no accidents** **no tripping**



Most economical solution as no wastage and can be self fabricated on site

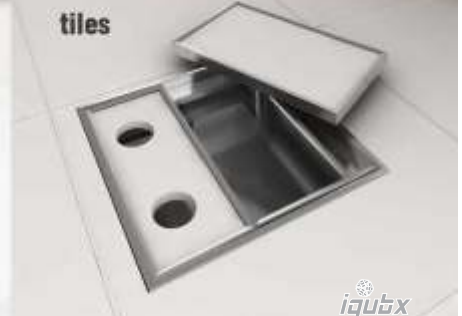

Double lid or infact any design & shape possible as per requirement



WEBSITE



Being truly modular, it is very flexible in design and construction. It can be readily prepared at the site from three types of extruded sections or modified to any size. It can be supplied finished in any dimensions of width, length and height, minimum ht being 50mm and minimum length and width being 150mm.

The sections of the floor junction box and the lid cover are designed to take high loads and can be designed to meet any requirement of size and load-bearing capacity. This allows the furniture and live loads to be handled without creaking and sagging. There is also the built-in flexibility of adding more number of columns to provide additional load bearing capacity as per requirements.

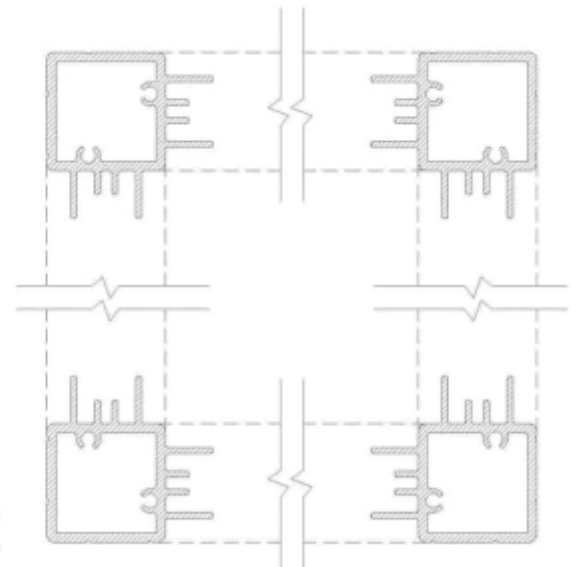
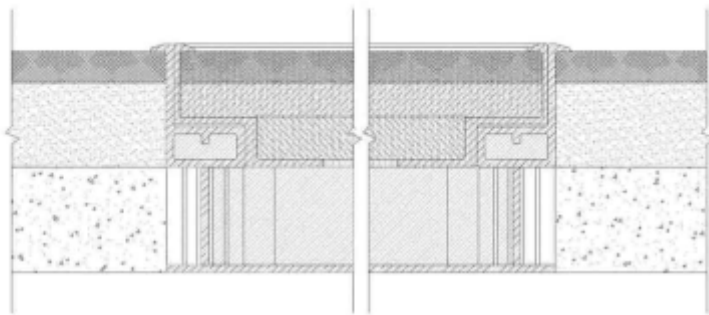

iqubx
JUNCTION BOX
SYSTEM
JB 022
SECTION

- 1. Vitrified or any other flooring material thickness will vary as per the material, and will be compensated for by different thicknesses of other materials of base, sub base and fiber matting
- 2. mortar for vitrified tile
- 3. Concrete base

- 4. Mortar block base / cast material below the floor/til material in the top of the junction box
- 5. Aluminium profile
 - 5a. JB022A column
 - 5b. JB022B (cover edge profile)
 - 5c. JB022C cover top edge profile
 - 5d. base plate made from aluminium or aluminium alloy
 - 5e. side wall made from aluminium or aluminium alloy

The design is subject to continuous change. Please refer to the latest version of the design and specifications for the latest information. The design is subject to change without notice.

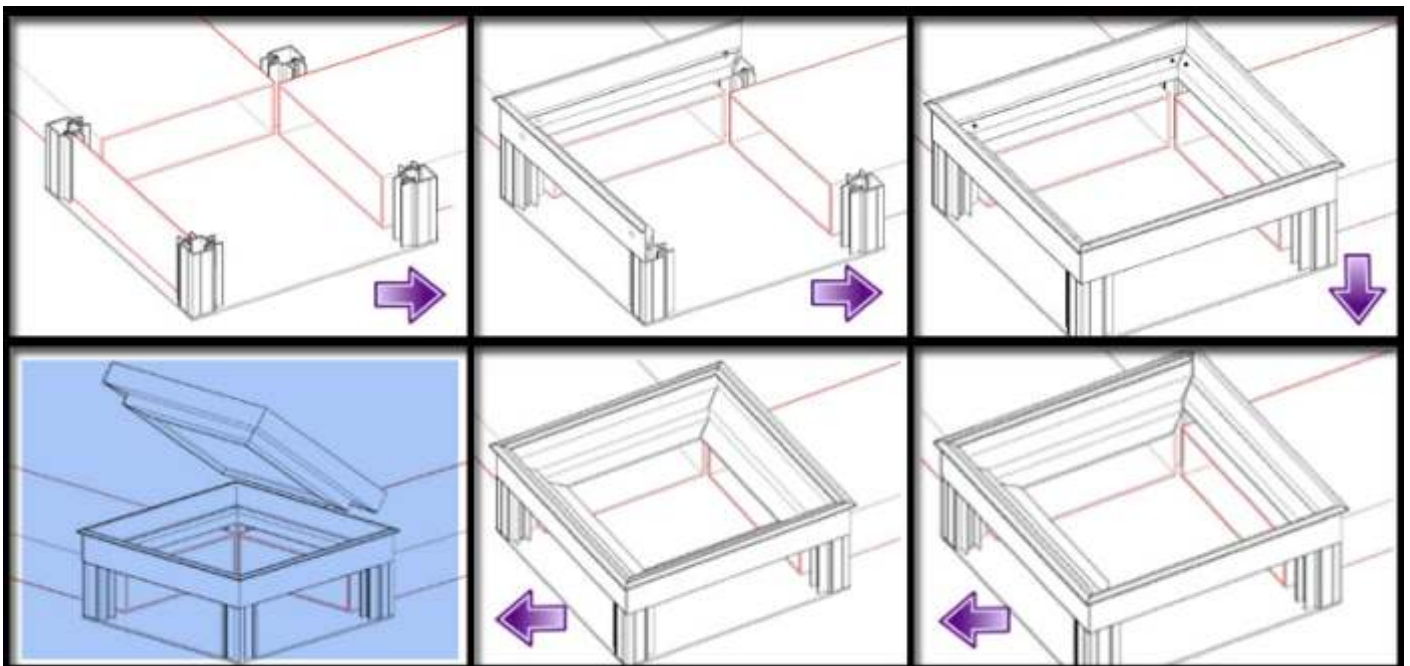



FLOOR JUNCTION BOX JB023

<https://iqubx.com/under-floor-junction-box/>

patent applied, fully flexible, strong floor junction box, upto 10mm floor finish in lid, ht. adjustable

Technical Data

Any length and width, less than 600
Minimum height 40mm to any ht.
Lid collar depth 20mm, can accommodate any floor finish upto 10 mm like tile, carpet, wood
JB023a, outer channel – 20 x 17.5 mm
JB023b, inner channel – 20 x 26 mm
JB023c, legs channel – 21 x 21 mm

Raw mill finish, can be powder coated in any color or anodized

GREENPRO certified 6063 aluminium alloy, 100% recycled aluminium - 10% pre- consumer & 90% post-consumer

- JB023 Lay-in lid type aluminium junction box
- JB023L Lay-in type lid and outer frame without legs to retrofit in existing MS / GI floor junction boxes
- JB023D Lay-in DOUBLE lid type aluminium junction box
- JB023H Lay-in lid HINGED type aluminium junction box

IQUBX JB023 modular floor junction box is patent design based on JB022 and has all the benefits and features, except it is **slimmer, can take lower loads and floor finishes upto 10mm only.**

It can easily accommodate flooring materials like carpet with 6mm ply backing, laminated ply and ply clad with SS or any other metal sheet etc.

It is **ideal for floors with low margin and smaller sizes upto 600 mm due to the lower load-bearing capacity of the lid cover.**

JB023 is Lighter in weight and more economical product with same functionality, aesthetics, strength and performance.



Both series JB's can be lifted by using vacuum cup or simply a screwdriver

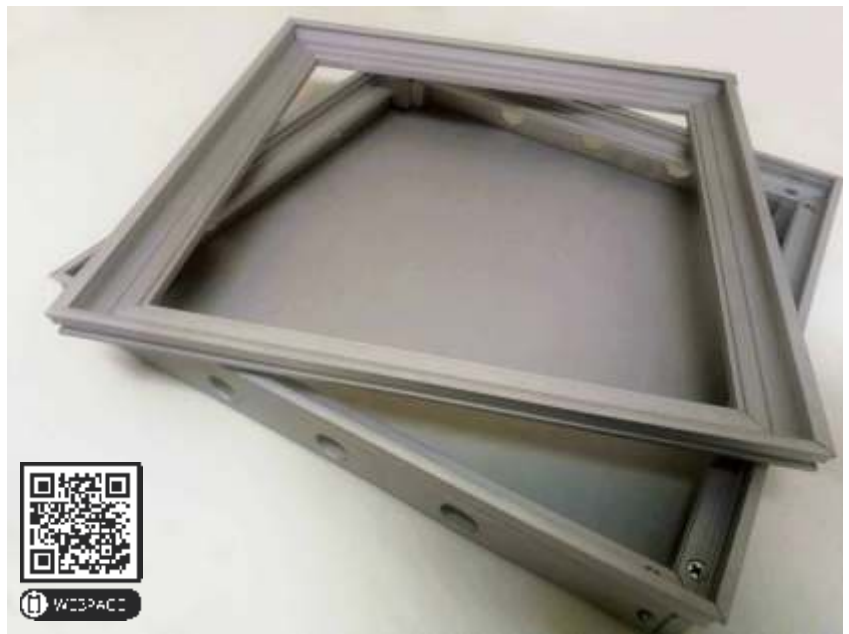

beautiful seamless floors

Patent IQUBX floor Junction Box trunking system

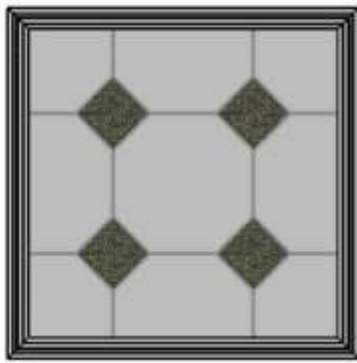

Top View

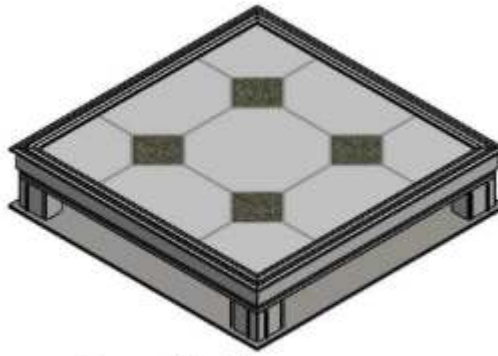

Iso-metric View



Front View

New Junction Box JB023

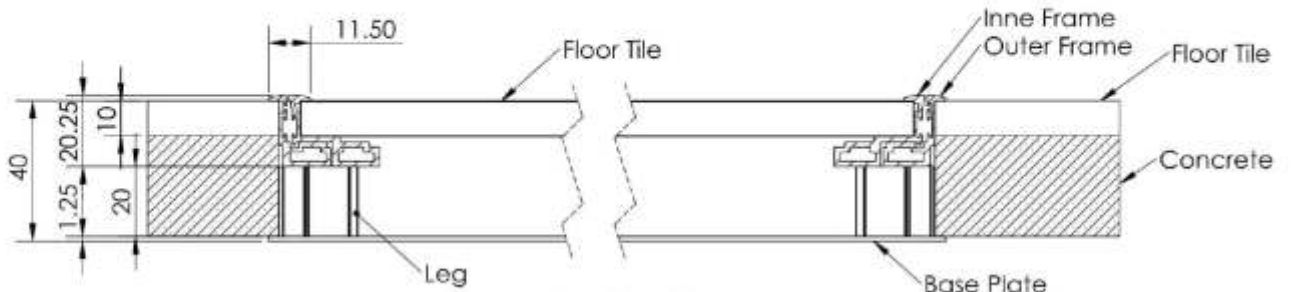

Section View

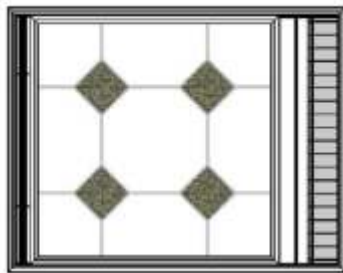

Top- View

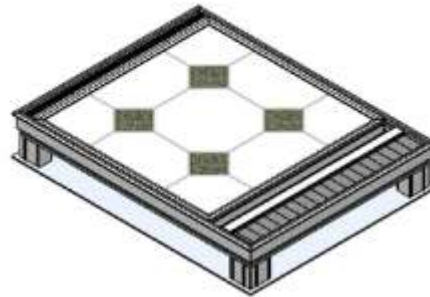

Iso-Metric View



Front View

Open-able Junction Box JB023 with Hinge

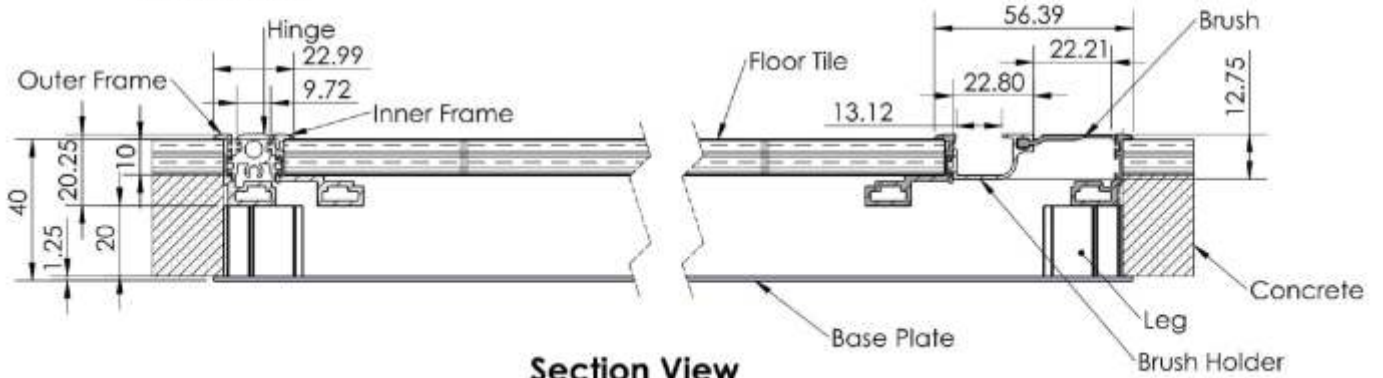

Section View



ELECTRICAL FLOOR BOX FB01





ELECTRICAL FLOOR BOX FB01

<https://iqubx.com/electrical-floor-box-outlet/>



completely modular customized floor box with n number of bays and length, as per req

It has been designed to be **just 55mm deep** for even low margin floors, unlike most other floor boxes which are around 90mm deep.



This makes it **highly modular and flexible** and for multipurpose use in floor as well as as fliptop box in conference table or work stations as well.

This electrical floor box design can accommodate **5 A sockets switches** in standard bays. The **15A switch sockets can be installed in additional seat** which can be integrated with the standard bay profile.

Similarly, for installing **low voltage outlets like AV, HDMI ports and data RJ45 ports of any quantity, inclined seat profile** can be added to the standard bay. It's inclined design base for mounting low power outlets allow the patch cords to be **usable even with the lid closed**.

A very important aspect of this design is that the box size of **258 mm x 258 mm can be retrofitted in existing standard floor box receptacle** and thus used to effectively replace defunct floor boxes.

Technical Data

Any length
Height 55mm
Width 165, 258, 351 mm for 1,2,3 bays for 5A, 15A switch / sockets and LV modules of any number

Raw mill finish, can be powder coated in any color or anodized

GREENPRO certified 6063 aluminium alloy, 100% recycled aluminium - 10% pre- consumer & 90% post-consumer

F B01 is a green certified **modular aluminium Floor box** made out of 100% recycled aluminium.

It is a **unique modular concept** where the floor box is created out of **modular bays**, which can be **of any length** as per requirement. The box can be constructed out of **1 bay, 2 bay or 3 bay or any number of bays**, as per requirement and the width and length of the electrical floor box will vary accordingly. As per the bays, **the width can vary as 165mm, 258mm or 351mm and so on**. Length can be any rational length as per requirement.



Key Features

Modular flexibility, any size is possible, not only any number and any type of sockets / ports can be accommodated, they can be modified / changed later

Green certified product: Certified by Indian Green Building Council, uses 100% recycled aluminium, almost entirely homogeneous and thus highly recyclable

The hinge is in-situ continuous and fail proof, smooth

The lid is also aluminium, which can be anodized / powdercoated

Can be retrofitted in existing defunct floor boxes like Legrand or MK floor boxes for easy rehabilitation

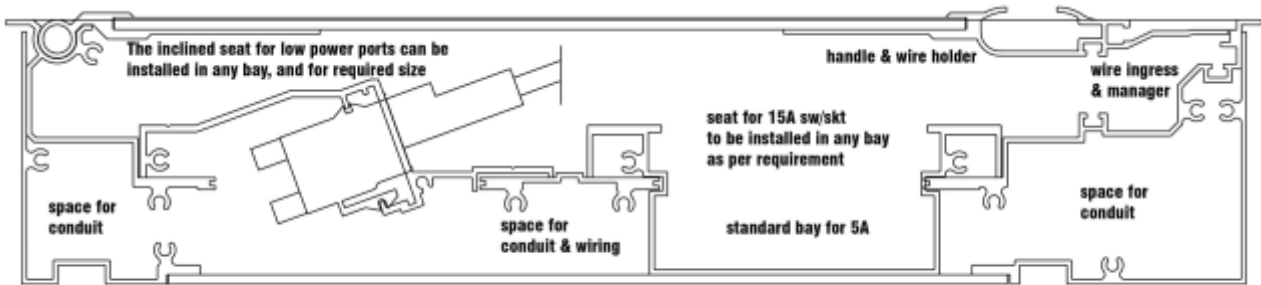

IQUBX FB01 electrical floor box outlet - 2 bay section



**IQUBX FB01
ELECTRICAL
FLOOR BOX OUTLET
can be retrofitted in existing
floor boxes cavity box base compartments**



FLOOR CABLE RACEWAY RW011

<https://iqubx.com/floor-cable-raceway/>



modular floor and wall cable raceway, excellent grip with substrate, can be laid flush to floor finish

Technical Data

150 X 45 mm
stackable in width in multiples of 150 mm
snap fit lid, can be laid exposed to the floor
usable on walls as well

Raw mill finish, can be powder coated in any color or anodized

GREENPRO certified 6063 aluminium alloy, 100% recycled aluminium - 10% pre-consumer & 90% post-consumer



QUBX RW011 Aluminium Modular Floor Cable Raceway System (may be used on walls and ceiling as well)

RW011 are **green certified (by IGBC, CII)** unique innovative Floor cable Raceways with **high load bearing capacity** and meant for demanding environments. These are **professionally designed systems** to suit contemporary interiors and can be used under floor, on floor as well as on walls.

They have some distinct features like Modular design – ready to install and assemble at site, **snap fit lid, horizontal interlocking and professionally designed profile** to maximize adherence to sub floor material. An optional divider can be used to carry the power and data cables in the same raceway as Aluminium is a non-magnetic material. **Being non-magnetic and non-corrosive, they are especially good for data cabling.**

Being Modular, **150 x 45** optimised size cable raceway unit can be **stacked horizontally**, multiplied in width with staggered interlocking to **300 x 45, 450 x 45** and so on. Thus, lead time in projects can be reduced to zero by stocking. Effectively, low buffer quantities on site are required and wastage is zero since left overs can be used in subsequent projects

No screws – **snap fit assembly of lid cover** speeds up the assembly and removal of cover, if required; Lighter unit weight is easier to handle, saving on labour

GREENPRO certified by IGBC, CII, made of Aluminium, an Environment-friendly material with low carbon foot print and possibility of reuse with high scrap value

Together with the IQUBX aluminium Modular Floor Junction Box JB022 and JB023, they form a complete under-floor trunking system.

All profiles RW011 available in 2440 mm length, made to order up to 4800 mm in raw aluminium finish

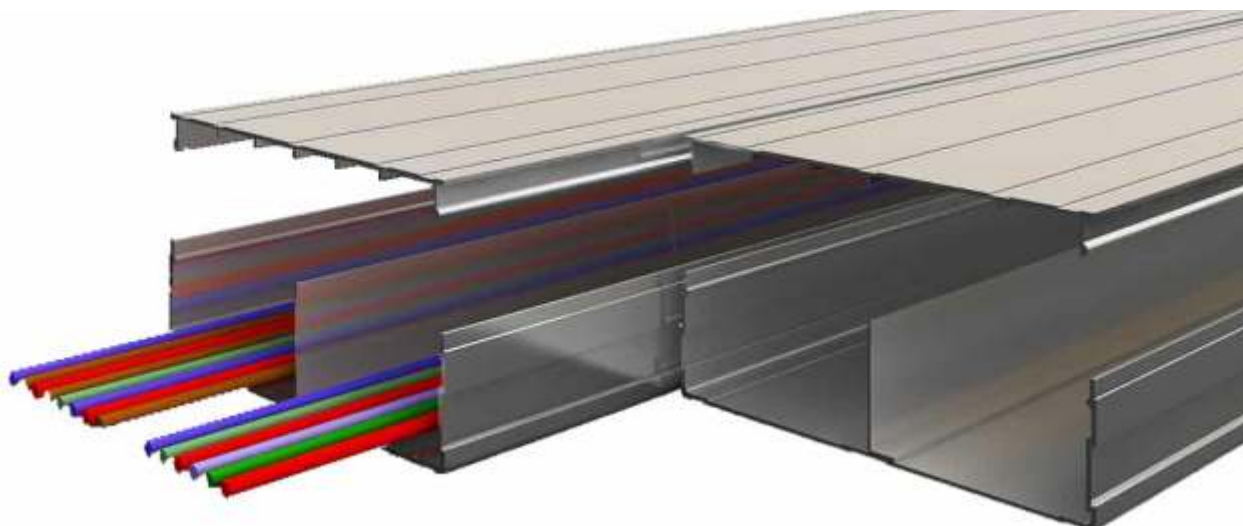
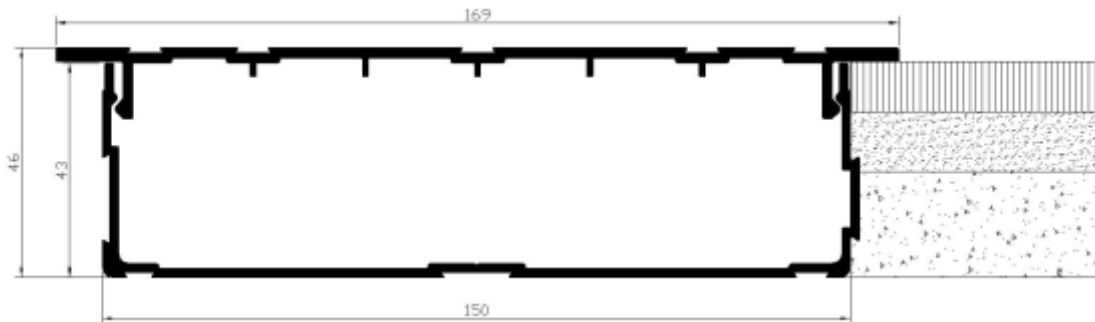



ELECTRICAL FLOOR BOX FB02

<https://iqubx.com/electrical-floor-box-outlet/>



modular customized floor box with 1 or 2 inclined bays and length as per req

Technical Data

Any length
Height 95mm
258 x 258 mm x 95 depth
5A, 15A switch / sockets and LV modules - 16M in all

Raw mill finish, can be powder coated in any color or anodized

GREENPRO certified 6063 aluminium alloy, 100% recycled aluminium - 10% pre- consumer & 90% post-consumer

QUBX FB02 is very innovative **modular Green pro certified** aluminium modular electrical floor box for under floor cable management and socket outlets. It is economical **green design with minimum number of components**, high strength & durability, very low maintenance and quick install.

In all **16 M** is available in the standard size **258 x 258 x 95** box. we recommend MK wraparound series switches sockets. These modules are placed in **inclined fashion** to allow very easy access to sockets and ports. Inside, 6 / 10 A and 16 / 20 A socket with switches can be accommodated. It is ideal for data and voice ports and other Low voltage ports, as per requirements

Being modular, other sizes can be made as per requirement beside the standard size of 258 x 258 x 95.

This highly engineered product is based on JB23 junction box (patent applied), and the **lid can accommodate floor finishes upto 10mm thick tile, carpet, wood etc.**

Double continuous wire management with integrated handles allows easy & flexible cable access. One can have one or two wire managers cum handles.

Continuous aluminium hinge makes it very durable and fail proof.



unique two side wire manager with integrated handles for maximum ease of functionality



The switch socket bay can be swivelled open for wiring



Lid can accommodate any finish upto 10mm like tile, carpet etc



No Cracked floors and no squeaking floor raceways, **sturdy and stable walls at every 150mm** or 80 mm and **ribbed lid cover provides structural stability**, allowing high furniture and live load without sagging or creaking.

The extruded profile has **grooves on all sides, allowing a strong grip to sub base material and avoiding cracks in the floor.**

They can be used as exposed cover cable Raceway, an elegant and permanent substitute for on-floor floor cable Raceway or over the floor electrical wire raceway in a floor in high-quality interiors.

It is an excellent solution because it is easily openable and makes the maintenance and modification of wires and cables very easy, besides being very trendy and contemporary. **This is an ideal solution for carrying cables across an existing interior too without extensive renovation.**



**FLOOR CABLE RACEWAY
RW033**

<https://iqubx.com/floor-cable-raceway/>



modular floor and wall cable raceway, excellent grip with substrate, can be laid flush to floor finish, used in IQUBX workstation systems for table raceways

RW033 is 100 x 55 raceway which can be used for underground raceways as well as exposed cover cable raceway.

It has been so designed that it acts as structural beam in IQUBX workstations as well as a cable carrier.

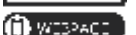
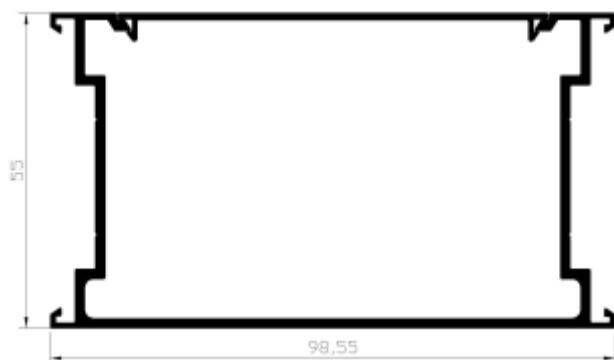

Technical Data
100 X 55 mm snap fit lid
Raw mill finish, can be powder coated in any color or anodized
GREENPRO certified 6063 aluminium alloy, 100% recycled aluminium - 10% pre- consumer & 90% post-consumer

Published April 2022



APPOINTING
DISTRIBUTORS
ALL OVER INDIA
& OUTSIDE

IQUBX PVT LTD
Plot No 22, khasra no 27/10,
Industrial Area, Nangli Sakrawati,
Near Campa Cola Factory,
Najafgarh, New Delhi, 110043

www.iqubx.com
<https://www.facebook.com/iqubx/>
<https://www.linkedin.com/company/iqubx/>
<https://www.instagram.com/iqubx/>

Modular Green Building Furniture & Interior Systems

Mktg +91 9999001967, 8506074444, 7065444402 | info@iqubx.com

The only certified Green Products in their categories in India

We design customized solutions

Modular Aluminum Interior products

Glass Partition Systems - Single, Double Glazed, DGU Glass
Demountable Wall Partition & Paneling Systems
Doors and Door Frames
Free standing office cabin partitions & booths
Dry Cladding Readymade Room Partition Walls (Drywall - Stone & Tiles)
Modular Baffle Ceiling Systems (PATENT applied)

Ceiling Trap Doors

Work Stations, Modular table Leg Systems, Modular Partitions, Popup Boxes
Misc: Skirting Board, Chair Rail, carpet transition profile, corner guard

Modular Aluminum Electrical products

Floor Boxes, Floor Junction Boxes (PATENT applied), Raceways
Floor Raceways Trunking Systems
Cable Distribution & Termination - Open Frame Racks - 2 & 4 Poles, D Ring



certified by
IGBC, CII

High performance & Functionality **Ultrafast installation** Minimum Human Labour
Highly customizable Modifiable **Relocatable** Minimum components

distributor



view auth
distributor
list online

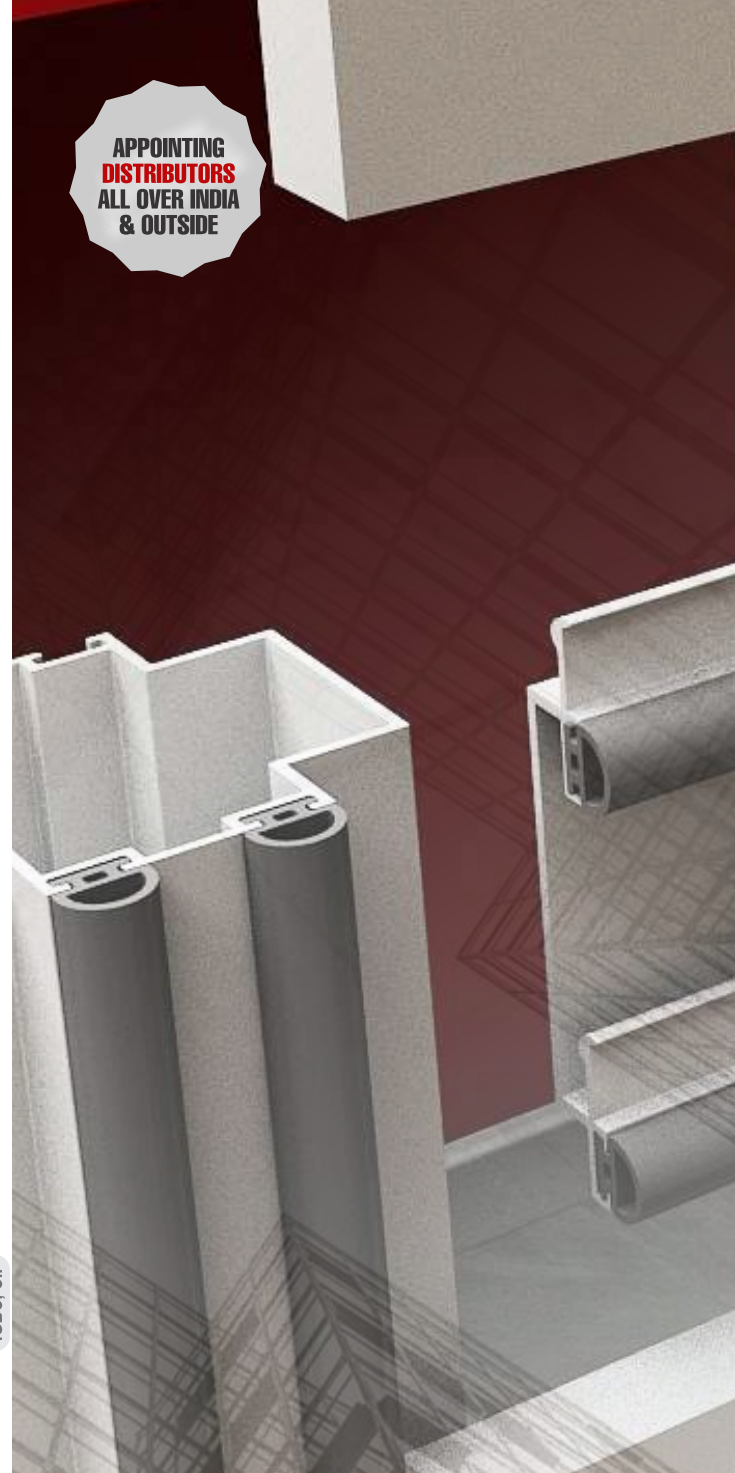

DESIGNERS & MANUFACTURERS
OF LARGEST NUMBER OF
GREEN CERTIFIED
MODULAR FURNITURE &
INTERIOR SYSTEMS IN INDIA

www.iqubx.com



All copyrights, trademarks, Intellectual property rights, patents reserved in name of IQUBX pvt ltd and its directors. Any copying of logo, images, designs, product designs without explicit written permission of the directors of IQUBX pvt ltd shall be a punishable offence. All the product designs are IPR protected