

All copyrights, trademarks, Intellectual property rights, patents reserved in name of IQUBX pvt ltd and its directors. Any copying of logo, images, designs, product designs without explicit written permission of the directors of IQUBX pvt ltd shall be a punishable offence. All the product designs are IPR protected



WEBSITE

**MODULAR
GLASS
PARTITION**
GP18100 S,D,V
GP2160 S,D,V
GP4028
GP2510
GP2512 S,D
GPC1415
GPC2060
GP(C)1750

Georgian bar
/ crittal / grid
glass systems

www.iqubx.com

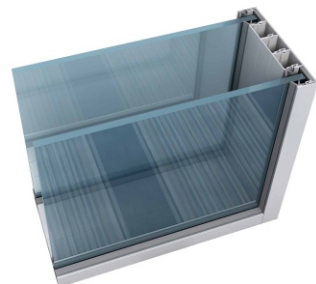

“
Our highly *flexible, high performance, customizable & reusable green certified interior systems can bring down capital cost and time of creating interiors from many weeks to a few days, with minimum labour – at optimal prices and minimum carbon footprint. They can even be reconfigured to match with evolving future requirements and can easily be relocated, saving huge investments and giving freedom to users in their decision making*
”



Features

-  Very Innovative, Unique and patent applied designs
-  Greenpro certified, made of recycled aluminum 6063 alloy T6 tempered
-  Sophisticated engineering
-  Very High performance
-  Made completely in India
-  BS 476 Part 6 Fire Propagation Class 0
BS 476 Part 7 Surface Spread of Flames Class 1
BS 6853:1999 .Smoke Emission. Pass
BS 6853: 1999. Toxic Fume Emission. Pass,
T6 6063 aluminium alloy is non-combustile, doesnt burn, melts with no gaseous release, has high thermal conductivity; powder coating on aluminium further enhances the fire resistant properties;

Benefits

-  Ultra Fast instalation on site
-  Minimum manpower on site
-  Very Economic pricing
-  Highly Customizable as per your requirements
-  High level modularity - Modifiable even post-installation
-  Relocatable
-  Minimum Turn-around-time
-  Minimum components for better logistics and maintenance
-  Made in India ensures future availability of spare components
-  Contributes to Sustainable project requirements
-  New Custom solutions designed as per your requirements

A few of our prestigious clients

AECOM



Tech Mahindra



SIEMENS



WAVE One



Exports to Canada, Maldives, Nepal

Awards & Recognitions

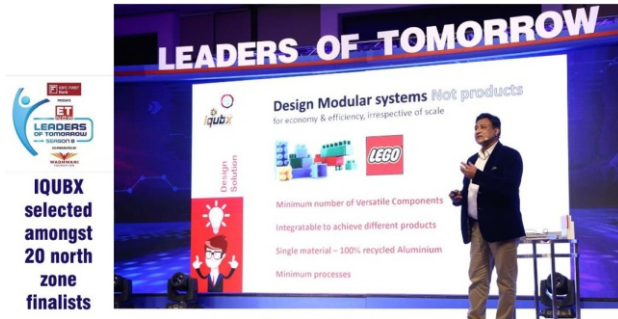
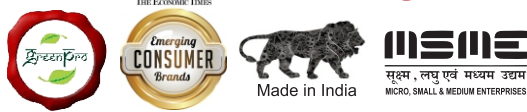

उद्योग आहार		Udyog Aahar																																																													
<p>Udyog Aahar Acknowledgment</p> <p>Udyog Aahar Number: 0211000000</p> <p>Name of Enterprise: IQUBX PRIVATE LIMITED</p> <p>Location of Plant Details:</p> <table border="1"> <tr> <th>S/N</th> <th>Registration No.</th> <th>Name of the manufacturing Unit</th> <th>Registration Date</th> <th>Assess Year</th> <th>Code</th> <th>Pin</th> <th>State</th> <th>District</th> </tr> <tr> <td>1</td> <td>B-14, GROUNDFLOOR, JEWAN GARDEN</td> <td>MAHATMA JEWAN ROAD, UTTAM NAGAR</td> <td>2016</td> <td>2016</td> <td>02</td> <td>110086</td> <td>DELHI</td> <td>WEST DELHI</td> </tr> </table> <p>Official Address of Enterprise: B-14, GROUNDFLOOR, JEWAN GARDEN, MAHATMA JEWAN ROAD, UTTAM NAGAR, DELHI - 110086</p> <p>Date of commencement: 28/03/2017</p> <p>Major Activity: MANUFACTURING</p> <p>Enterprise Type: MSME</p> <p>Previous Registration details if any: 0211000000</p> <p>Verbal History Classification Code: A</p>				S/N	Registration No.	Name of the manufacturing Unit	Registration Date	Assess Year	Code	Pin	State	District	1	B-14, GROUNDFLOOR, JEWAN GARDEN	MAHATMA JEWAN ROAD, UTTAM NAGAR	2016	2016	02	110086	DELHI	WEST DELHI																																										
S/N	Registration No.	Name of the manufacturing Unit	Registration Date	Assess Year	Code	Pin	State	District																																																							
1	B-14, GROUNDFLOOR, JEWAN GARDEN	MAHATMA JEWAN ROAD, UTTAM NAGAR	2016	2016	02	110086	DELHI	WEST DELHI																																																							
<table border="1"> <thead> <tr> <th>SN</th> <th>MSME Code</th> <th>MSME Code</th> <th>Activity Type</th> </tr> </thead> <tbody> <tr> <td>01</td> <td>2220</td> <td>2220</td> <td>Manufacture of plastic products</td> </tr> <tr> <td>02</td> <td>2220</td> <td>2220</td> <td>Manufacture of rubber and plastic products</td> </tr> <tr> <td>03</td> <td>2220</td> <td>2220</td> <td>Manufacture of leather goods</td> </tr> <tr> <td>04</td> <td>2220</td> <td>2220</td> <td>Manufacture of metal products</td> </tr> <tr> <td>05</td> <td>2220</td> <td>2220</td> <td>Manufacture of other metal products</td> </tr> <tr> <td>06</td> <td>2220</td> <td>2220</td> <td>Manufacture of wood products</td> </tr> <tr> <td>07</td> <td>2220</td> <td>2220</td> <td>Manufacture of other wood products</td> </tr> <tr> <td>08</td> <td>2220</td> <td>2220</td> <td>Manufacture of paper products</td> </tr> <tr> <td>09</td> <td>2220</td> <td>2220</td> <td>Manufacture of other paper products</td> </tr> <tr> <td>10</td> <td>2220</td> <td>2220</td> <td>Manufacture of textile products</td> </tr> <tr> <td>11</td> <td>2220</td> <td>2220</td> <td>Manufacture of other textile products</td> </tr> <tr> <td>12</td> <td>2220</td> <td>2220</td> <td>Manufacture of food products</td> </tr> <tr> <td>13</td> <td>2220</td> <td>2220</td> <td>Manufacture of other food products</td> </tr> <tr> <td>14</td> <td>2220</td> <td>2220</td> <td>Manufacture of other products</td> </tr> </tbody> </table>				SN	MSME Code	MSME Code	Activity Type	01	2220	2220	Manufacture of plastic products	02	2220	2220	Manufacture of rubber and plastic products	03	2220	2220	Manufacture of leather goods	04	2220	2220	Manufacture of metal products	05	2220	2220	Manufacture of other metal products	06	2220	2220	Manufacture of wood products	07	2220	2220	Manufacture of other wood products	08	2220	2220	Manufacture of paper products	09	2220	2220	Manufacture of other paper products	10	2220	2220	Manufacture of textile products	11	2220	2220	Manufacture of other textile products	12	2220	2220	Manufacture of food products	13	2220	2220	Manufacture of other food products	14	2220	2220	Manufacture of other products
SN	MSME Code	MSME Code	Activity Type																																																												
01	2220	2220	Manufacture of plastic products																																																												
02	2220	2220	Manufacture of rubber and plastic products																																																												
03	2220	2220	Manufacture of leather goods																																																												
04	2220	2220	Manufacture of metal products																																																												
05	2220	2220	Manufacture of other metal products																																																												
06	2220	2220	Manufacture of wood products																																																												
07	2220	2220	Manufacture of other wood products																																																												
08	2220	2220	Manufacture of paper products																																																												
09	2220	2220	Manufacture of other paper products																																																												
10	2220	2220	Manufacture of textile products																																																												
11	2220	2220	Manufacture of other textile products																																																												
12	2220	2220	Manufacture of food products																																																												
13	2220	2220	Manufacture of other food products																																																												
14	2220	2220	Manufacture of other products																																																												



◀ Widest
range of
Green
certified
Modular
Interior
Systems ▶



MODULAR BAFFLE CEILING

CEILING TRAP DOORS

GLASS PARTITION SYSTEMS

DOOR AND DOOR FRAMES

**DEMOUNTABLE PARTITION SYSTEMS
PANELING SYSTEMS**

DRY WALL CLADDING PARTITIONS FOR WET AREAS

WORK STATIONS LEG SYSTEMS

FLIPTOP BOX FOR WORKSTATIONS

MODULAR WORKSTATION PARTITIONS

**ELECTRICAL TRUNKING SYSTEMS
FLOOR JUNCTION BOX
FLOOR BOX
FLOOR RACEWAYS**

OPEN MODULAR FRAME STRUCTURE SYSTEM

CABLE TERMINATION RACK - DISTRIBUTION RACK

SKIRTING BOARD

CHAIR RAILS, CORNER GUARD, CARPET TRANSITION PROFILE



**MODULAR
GLASS PARTITION
GP18100 S/D/V**

<https://iqubx.com/glass-partition/>



Technical Data

Partition assembled section – 18 x 100

Main channel - GP18100a - 9 x 100 mm

Edge channel - GP18100b - 18 x 4 mm

Center channel - GP18100c - 14 x 20 mm

VIG channel - GP18100d - 23 x 20 mm

All components are raw mill finish and can be powder coated in any powder coat color or anodized

Various glass thickness can be accommodated 10mm to 12mm float glass

It gives superior acoustic insulation due to modular discontinuity across the section GP18011D is STC 54 certified

GREENPRO certified 6063 aluminium alloy, 100% recycled aluminium - 10% pre-consumer & 90% post-consumer

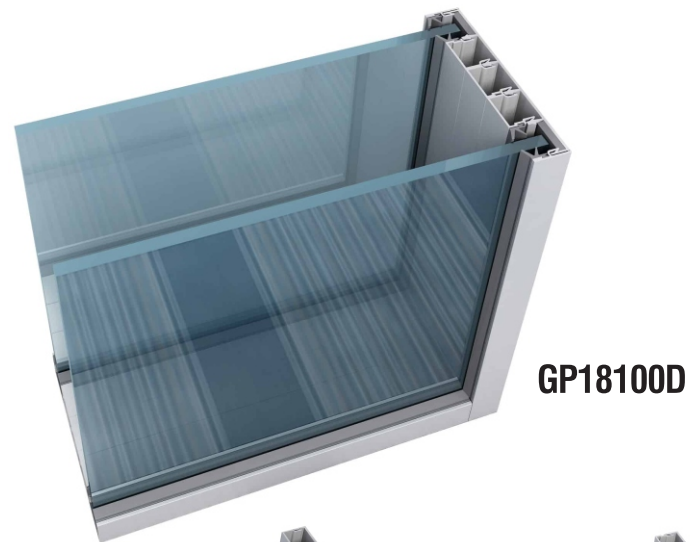

GP18100D

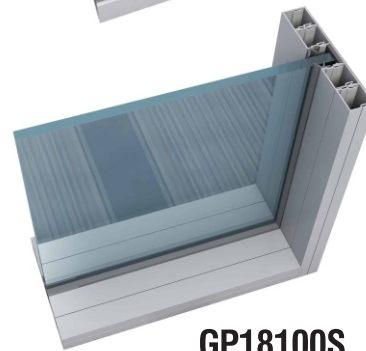

GP18100S



GP18100V

100 wide with multiple glazing options of single glass, double glass and Vacuum insulated glass

This is a revolutionary **ultra-slim** modular glass partition wall design from IQUBX where a single system is designed to accommodate **multiple glazing options**.

This glass partition system can accommodate **single glass, double glass, even 3 glasses and Vacuum Insulated Glass (VIG)**, also called Double Glass Unit (DGU) too.

Glazing pane options

GP18100S Single glass – Glass in center, 10mm, 12mm

GP18100D Double glass – Glass on both edges, 8mm, 10mm

GP18100V Vacuum Insulated Glass / Double glass unit in center, 18mm (5mm + 5mm + 8mm gap) to 24mm

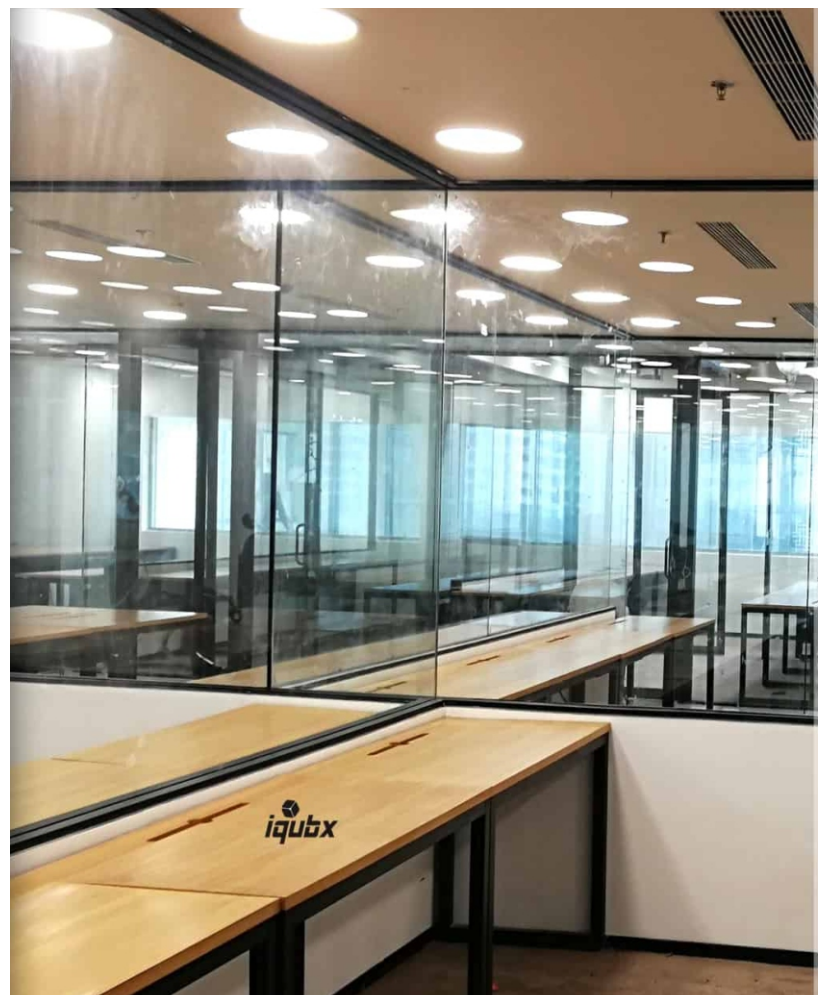

Gp18100 new improved section with greater thickness, groove at base, better accoustics - 22 x 100

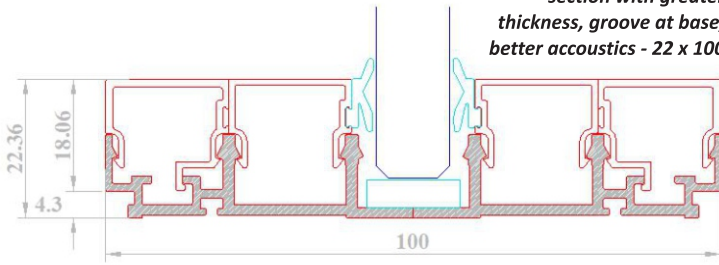

Major advantages - benefits

The glass panels can be changed including their configuration of 1,2 or VIG / DGU glass, even after installation. Therefore, when it is felt that a certain cabin needs to be more acoustically insulated, the single glass can be upgraded to double glass or VIG glass without any problem. Glass of 8mm to 12mm can be used and VIG of 18 to 25mm is ideal.

A single glass partition system will be able to fulfill project requirement of different glass wall systems, thus, reducing on logistics & wastage.

GP18100 is very easy to install and can be integrated with other IQUBX system like Door Frame DF01, Glass Door GD01, GD02, Demountable Partition system WP01P and many more

The new aesthetics is distinct and adds to exclusiveness

The system is very easy to maintain, repair, change

GP18100D is STC54 certified which makes it ideal for dense office use where sound insulated cabins and spaces are required

14-B, I.P. Estate, New Delhi-11002, Tel: 23378211-12 E-mail: info@iqubx.com, accounts@iqubx.com

Prasad Bharati
Public Service Broadcaster of India
O/o ADD (E), Research & Development, AIR & DD
14-B, I. P. Estate, Ring Road, New Delhi - 110002

Test Report no.28/2019-20 Dated: 22.11.2019

Description of test Specimen	Description of Test Laboratory
Client: M/s IQUBX Pvt. Ltd.	Volume of RT Room: 60 m ³
Customer: Mr. Rajiv Verma	Temperature: 24.1 °C
Sample name: Double glass aluminium Partition system IQUBX GP 18100	Humidity: 15 %
Test combination: Double glass with aluminium frame	Sample area: 1.917 m ²
Thickness:	Type of Noise Used: Pink
	Equipment: Building Acoustic Analyzer

Testing Place: Acoustic Lab

Pankaj Tripathi
Asstt. Engineer 28/11/2019

M. M. M.
Director (E)

14-B, I.P. Estate, New Delhi-11002, Tel: 23378211-12 E-mail: info@iqubx.com, accounts@iqubx.com

GreenPro **CIH**
GreenPro Certification Confederation of Indian Industry

CIH-Green Products and Services Council
hereby certifies that
Aluminium Modular Glass Partition (GP18100)
(IQUBX5020)

manufactured by IQUBX Private Limited at their plant in Delhi, meets the requirements of GreenPro Certification and qualifies as a Green Product.
This certification is valid till December 2022

Amal K. Gade *Pratibha R.* *K. S. Venkatesh*
Chairman, CIH Green Council Chairman, CIH Green Products & Services Council Executive Director, CIH Green Council

Sound Insulation Characteristics

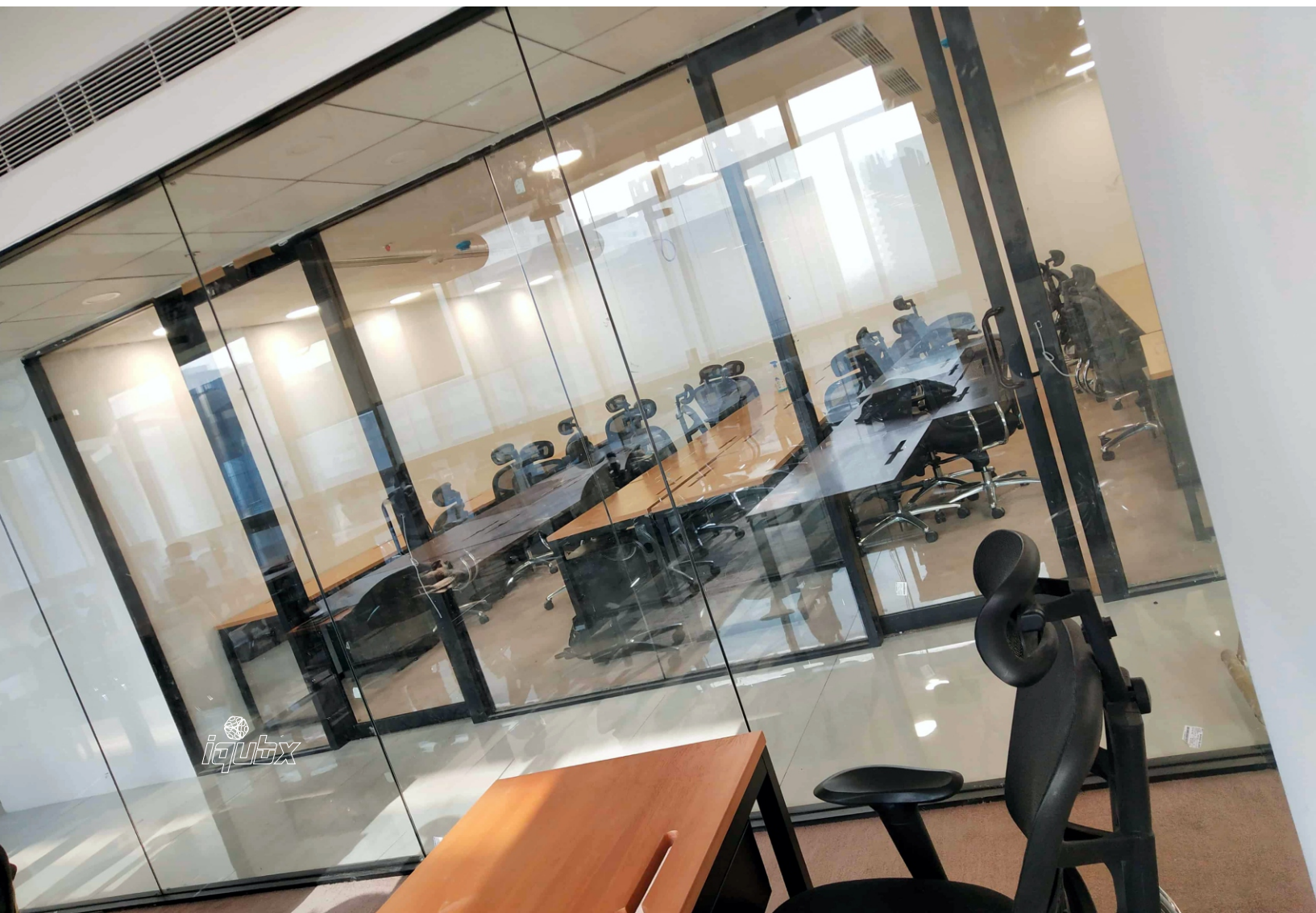

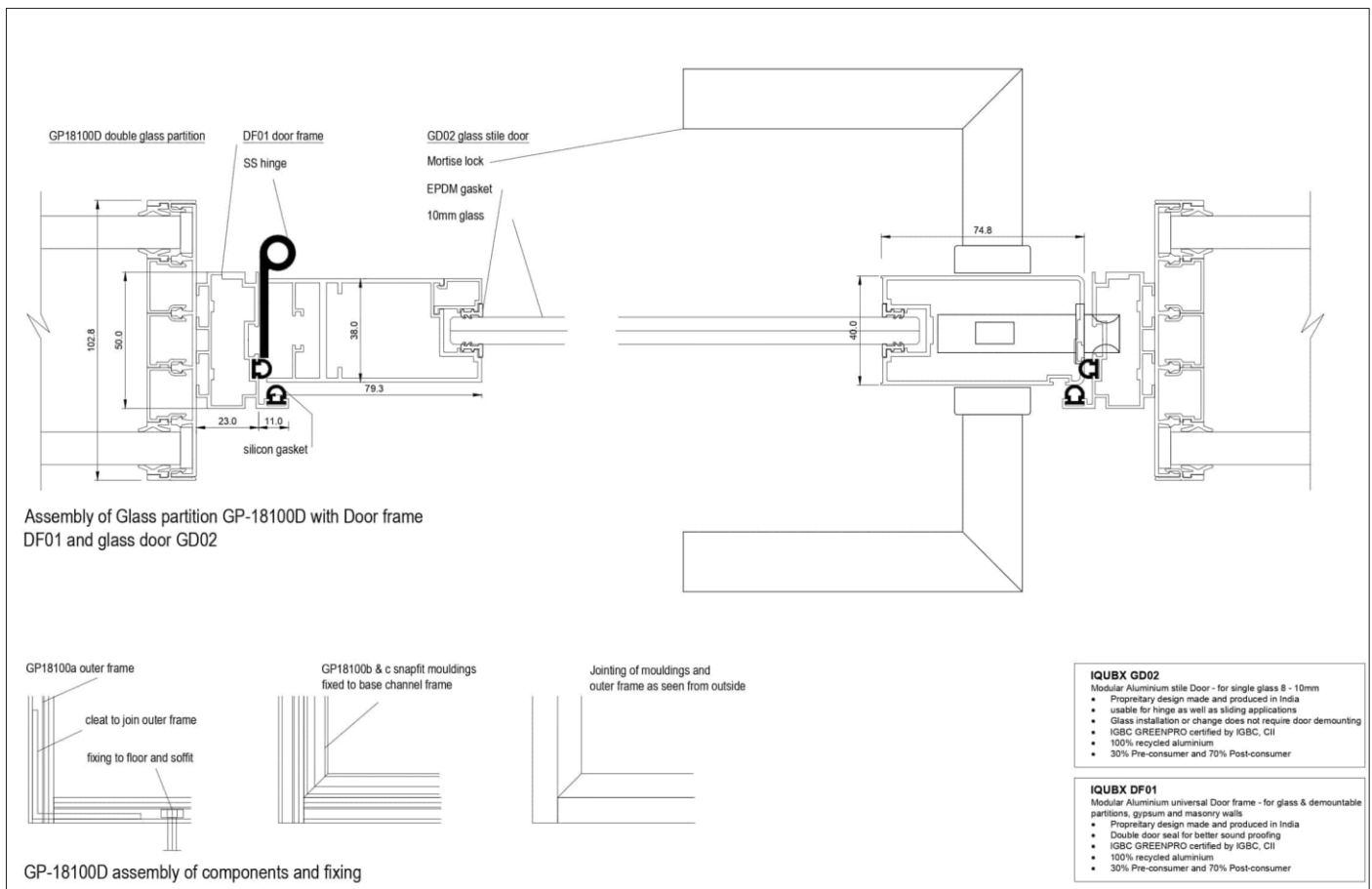
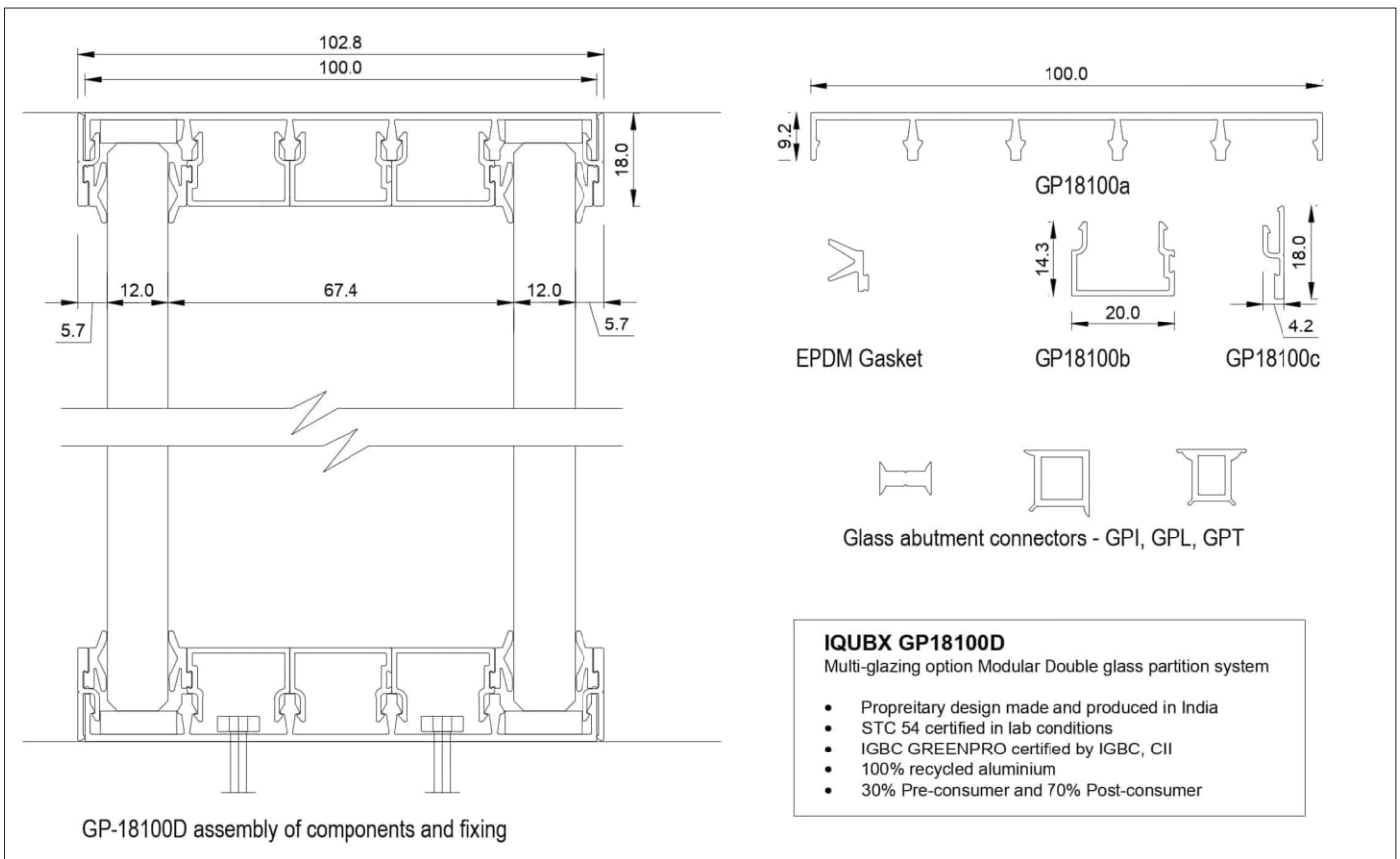



<https://iqubx.com/glass-partition/>

60 mm wide with multiple glazing options of single glass, double glass and Vacuum insulated glass in same system

This is an optimized version of the revolutionary GP18100 series. This Iqubx glass partition system is designed to accommodate multiple glazing options like single glass, double glass and Vacuum Insulated Glass (VIG). It is slightly thicker at 21mm and less wide with just 60mm footprint. It has better acoustic performance even with single glass. It is stronger and has innovative joinery to form frames with inner brackets and nut-bolts. It has a 3mm groove at base for better detailing.

The glass panels can be changed including their configuration of 1,2 or VIG / DGU glass, even after installation. Therefore, when it is felt that a certain cabin needs to be more acoustically insulated, the single glass can be upgraded to double glass or VIG glass without any problem. A single glass partition system will be able to fulfill project requirement of different glass wall systems, thus, reducing on logistics & wastage.

Technical Data

Partition assembled section – 21 x 60

- Main channel - GP2160a - 12 x 60 mm
- Edge channel - GP18100b - 18 x 4 mm
- Center channel - GP18100c - 14 x 20 mm
- Center channel - GP2160c - 14 x 20 mm
- VIG channel - GP18100d - 23 x 20 mm

All components are raw mill finish and can be powder coated in any powder coat color or anodized

Various glass thickness can be accommodated 10mm to 12mm float glass

It gives superior acoustic insulation due to modular discontinuity across the section
GP2160S is **STC 45 certified**

GREENPRO certified 6063 aluminium alloy, 100% recycled aluminium - 10% pre- consumer & 90% post-consumer

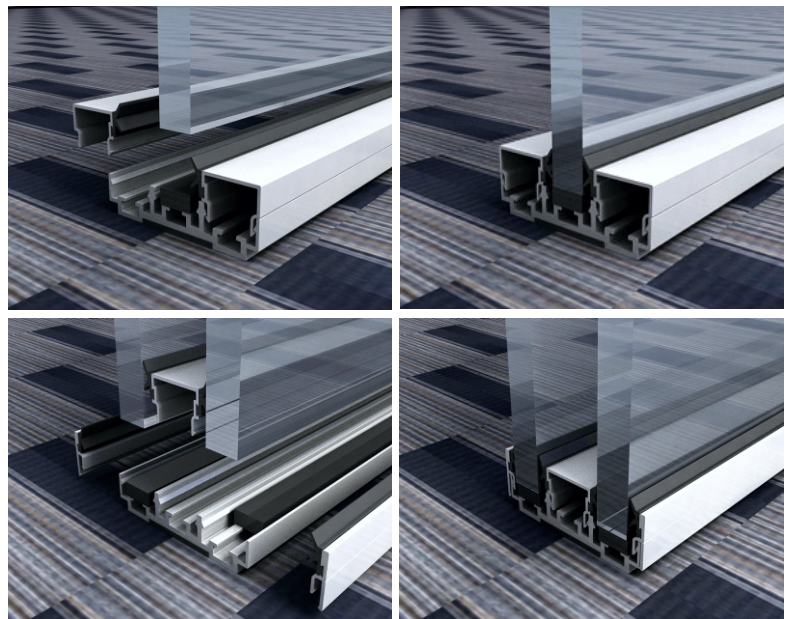

an underconstruction site

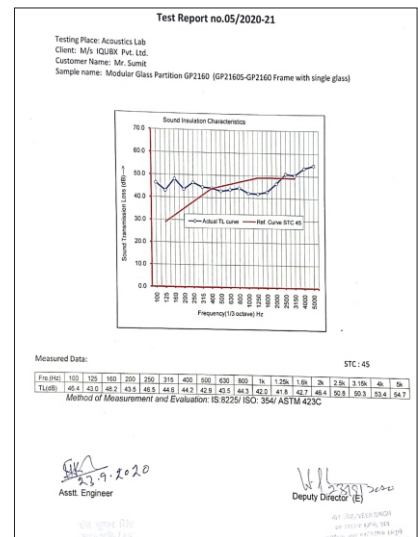

WEBPAGE

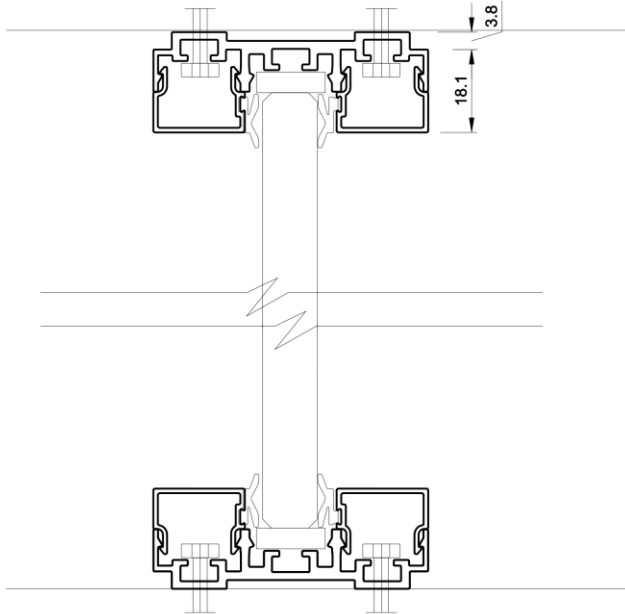

GP-2160S assembly of components and fixing

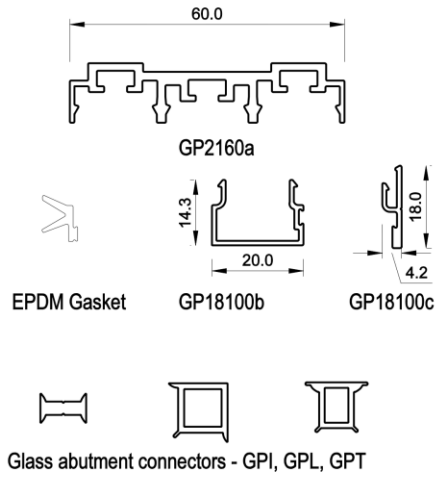

IQUBX GP2160S
Multi-glazing option Modular Single glass partition system

- Proprietary design made and produced in India
- STC 45 certified in lab conditions
- IGBC GREENPRO certified by IGBC, CII
- 100% recycled aluminium
- 30% Pre-consumer and 70% Post-consumer

<p>IQUBX B 19, Kiran Garden, Matiala Road Uttam Nagar, NEW DELHI - 110059 +91 9811204811, 9310488830 amit@creativeviewzards.in, creativeviewz@gmail.com</p>	<p><small>This design and drawing is intellectual property of IQUBX Pvt. Ltd and the Director/Owner and cannot be copied/used for any other purpose. It is permitted to be shared within the premises of the Director of IQUBX. Any other appropriate legal action may be taken.</small></p>	PROJECT	Revision	Date	Particulars	SHEET TITLE:	Date:- 01-10-20
		CHECKED BY: A.G				GP-2160S	IQ/GP2160/1
		DRAWN BY: tab					

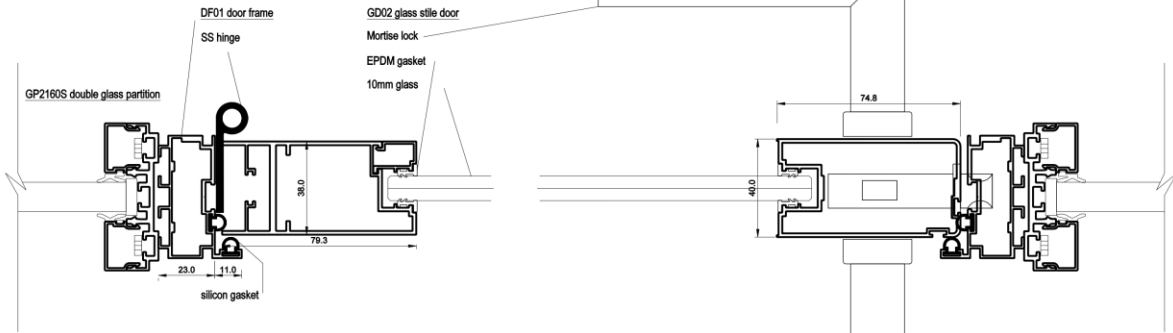

Assembly of Glass partition GP-2160S with Door frame DF01 and glass door GD02

- IQUBX GD02**
Modular Aluminium stile Door - for single glass 8 - 10mm
- Proprietary design made and produced in India
 - Suitable for hinge as well as sliding applications
 - Glass installation or change does not require door demounting
 - IGBC GREENPRO certified by IGBC, CII
 - 100% recycled aluminium
 - 30% Pre-consumer and 70% Post-consumer

- IQUBX DF01**
Modular Aluminium universal Door frame - for glass & demountable partitions, gypsum and masonry walls
- Proprietary design made and produced in India
 - Double door seal for better sound proofing
 - IGBC GREENPRO certified by IGBC, CII
 - 100% recycled aluminium
 - 30% Pre-consumer and 70% Post-consumer

<p>IQUBX B 19, Kiran Garden, Matiala Road Uttam Nagar, NEW DELHI - 110059 +91 9811204811, 9310488830 amit@creativeviewzards.in, creativeviewz@gmail.com</p>	<p><small>This design and drawing is intellectual property of IQUBX Pvt. Ltd and the Director/Owner and cannot be copied/used for any other purpose. It is permitted to be shared within the premises of the Director of IQUBX. Any other appropriate legal action may be taken.</small></p>	PROJECT	Revision	Date	Particulars	SHEET TITLE:	Date:- 01-10-20
		CHECKED BY: A.G				assembly detail GP-2160S + DF01 + GD02	IQ/GP2160/3
		DRAWN BY: tab					



MODULAR GLASS PARTITION GP4028

<https://iqubx.com/glass-partition/>

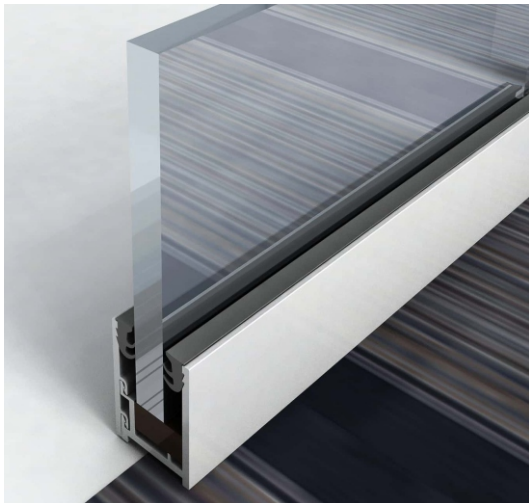
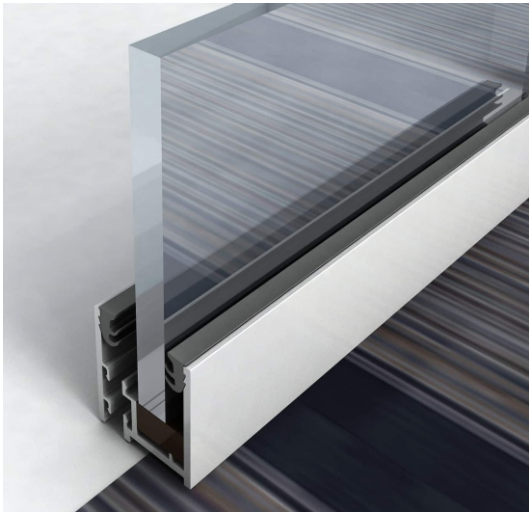

28 mm wide for single glass, 48mm high with double lock snap moulding, high acoustic performance

IQUBX GP4028 is a premium, heavy weight, maintenance free, greenpro certified glazed partition system designed for superior acoustic performance.

This system has sleek snap-fit sections, enabling easy assembly or change of glass, without creating any chaising in the floor or ceiling. Being, modular, they can be removed and re-enacted at any other location without too much wastage, even if size needs to be changed.

We recommend 10 to 12 mm float glass be used with GP4028.

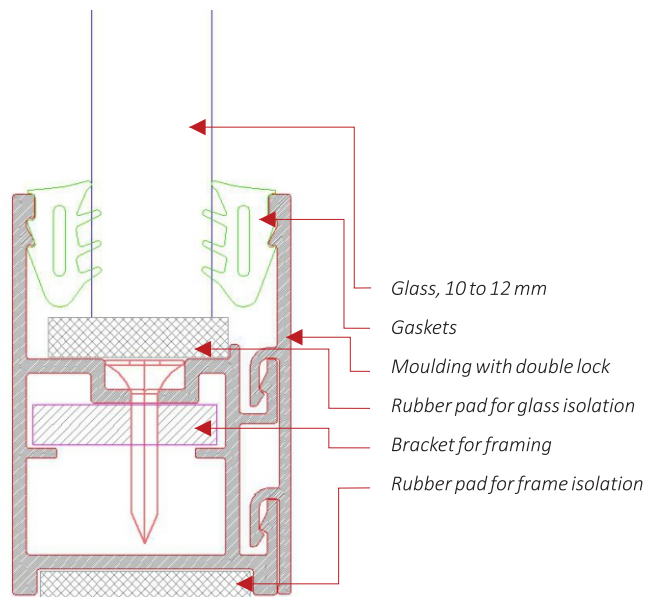

Technical Data

Partition assembled section – 40 x 28

Main channel - GP4028a - 40 x 26.4 mm

Edge channel - GP4028b - 40 x 4.2 mm

All components are raw mill finish and can be powder coated in any powder coat color or anodized

Various glass thickness can be accommodated 10mm to 12mm float glass

This model gives superior acoustic insulation

GREENPRO certified 6063 aluminium alloy, 100% recycled aluminium - 10% pre- consumer & 90% post-consumer



WEBPAGE



MODULAR GLASS PARTITION GPC1415 faux

<https://iqubx.com/glass-partition/>

14 x 15 mm add on grid system, modular, modifiable, can be used in existing glass

This is a sleek non-structural add-on modular grid for an existing or new glass partition, which has to be added from both sides of the glass. The design is such that it can be used on any kind of existing glass partition – frame less, aluminium glass partition or wooden glass partition.

The joint has been designed for complete ease and flexibility with strength. The edge of the profile is just 15mm. With the depth of just 14mm, it can be easily installed on doors, windows and sliding partitions as well.

The best finish for this system style is black or white powder coating, though it can be in any shade of powdercoat, wooden powdercoat or anodizing.



Technical Data

14 x 15 on any glass, ideally installed from both sides

powder coat color or anodized

GREENPRO certified 6063 aluminium alloy, 100% recycled aluminium- 10% pre-consumer & 90% post-consumer

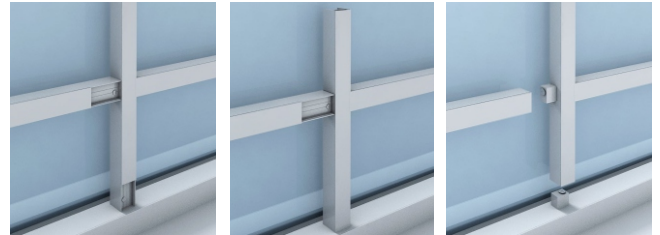

MODULAR GLASS PARTITION GP(C)1750

17 x 50 mm ultra-sleek glass and grid-glass partition system

Ultra - sleek structural modular glass partition which can also accommodate grid designs.

The face side is just 17mm including snap-fit moulding of 5.3mm. The design allows this thin marvel of engineering to be further finished in two separate colours / finishes to give almost an unreal sleek edge.

However, the thickness of the section wall is quite substantial giving ample structural strength. The various parts can be finished in any shade of powdercoat, wooden powdercoat or anodizing.

Technical Data

6063T6 alloy 17 x 50 mm
Main channel 12 x 50
Crittall grid channel 6 x 50
Moulding 5.5 x 17
powder coat color or anodized

GREENPRO certified 6063 aluminium alloy, 100% recycled aluminium- 10% pre-consumer & 90% post-consumer

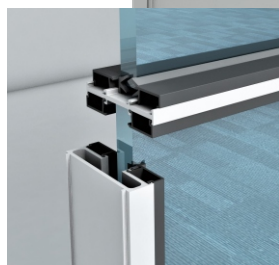
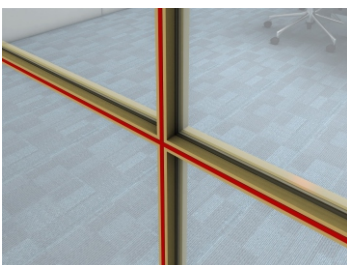



**MODULAR
GLASS PARTITION
GPC2060**

<https://iqubx.com/glass-partition/>



WEBPAGE

20 x 60 mm true structural grid system, modular, modifiable



Our high performance engineered aluminium design of GPC2060 offers all design and style capabilities of the classic urban deco style look.

With the edge profile of just 20mm, it is a **structural load bearing partition system** with **flexibility of any grid pattern and size**.

Critical look Aluminium Glass partition IQUBX GPC2060 is very easy to assemble and fix in any size and grid configuration on site, with the basic channels supplied. It is designed to take glass of 8mm which may be float glass or toughened.

The best finish for this system style is black or white powder coating, though it can be provided in any shade of powdercoat or anodizing as per requirement.

Technical Data



20 x 60 mm for 8 mm glass

All components are raw mill finish and can be powder coated in any powder coat color or anodized

GREENPRO certified

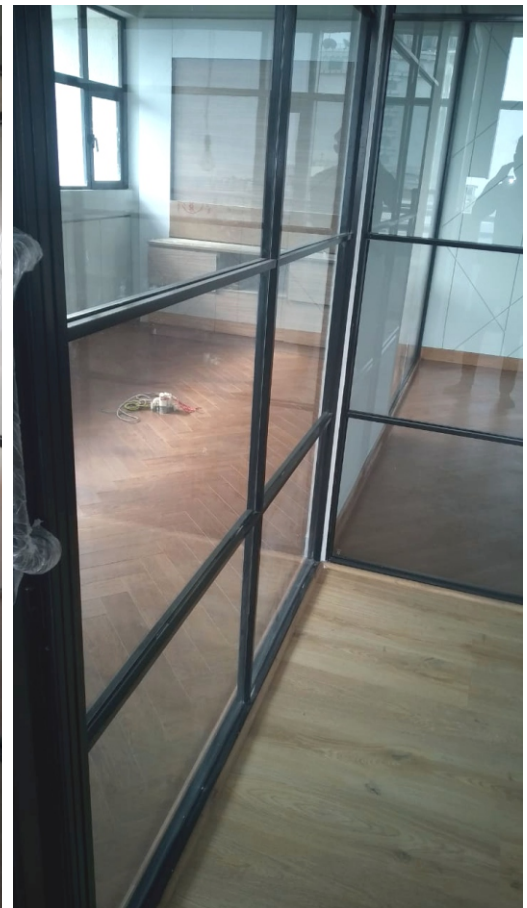
6063 aluminium alloy, 100% recycled aluminium - 10% pre-consumer & 90% post-consumer



**MODULAR
GLASS PARTITION
GP2510, 2512(D)**

<https://iqubx.com/glass-partition/>

25 mm high for single glass and double glass, good acoustic performance



WEBPAGE

Technical Data

GP2510	25 X 41.5	for 8-10mm glass
GP2512	25 X 50	for 10-12mm glass
GP2512D	25 X 100	for 2 x 10-12mm glass

All components are raw mill finish and can be powder coated in any powder coat color or anodized

GREENPRO certified 6063 aluminium alloy, 100% recycled aluminium - 10% pre- consumer & 90% post-consumer

IQUBX GP2510 and GP2512(D) are maintenance free, greenpro certified durable glazed partition systems which can be assembled very quickly in a non-messy way.

These systems have sleek snap-fit sections, enabling easy assembly or change of glass, without creating any chaising in the floor or ceiling. Being, modular, they can be removed and re-enacted at any other location without too much wastage, even if size needs to be changed. Since they are framed, float glass can be used, saving time and money, and float glass can be resized on relocation.

We recommend that 8 to 10 mm float glass be used with GP2510, while GP2512 / GP2512D can hold 10 to 12mm glass.

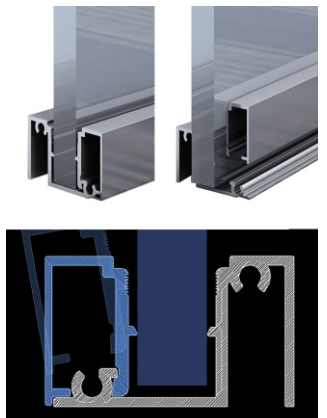
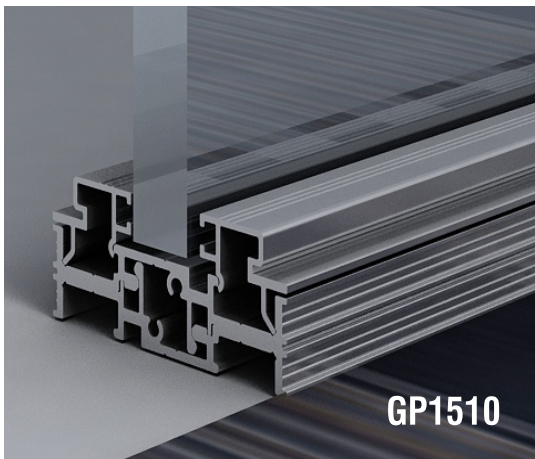

Published Dec 2022



APPOINTING DISTRIBUTORS ALL OVER INDIA & OUTSIDE



IQUBX PVT LTD
Plot No 22, khasra no 27/10,
Industrial Area, Nangli Sakrawati,
Near Campa Cola Factory,
Najafgarh, New Delhi, 110043

www.iqubx.com
<https://www.facebook.com/iqubx/>
<https://www.linkedin.com/company/iqubx/>
<https://www.instagram.com/iqubx/>

Modular Green Building Furniture & Interior Systems

Mktg +91 9999001967, 8506074444, 7065444402 | info@iqubx.com
The only certified Green Products in their categories in India

We design customized solutions

Modular Aluminum Interior products

- Glass Partition Systems - Single, Double Glazed, DGU Glass
- Demountable Wall Partition & Paneling Systems
- Doors and Door Frames
- Free standing office cabin partitions & booths
- Dry Cladding Readymade Room Partition Walls (Drywall - Stone & Tiles)
- Modular Baffle Ceiling Systems (PATENT applied)
- Ceiling Trap Doors
- Work Stations, Modular table Leg Systems, Modular Partitions, Popup Boxes
- Misc: Skirting Board, Chair Rail, carpet transition profile, corner guard

Modular Aluminum Electrical products

- Floor Boxes, Floor Junction Boxes (PATENT applied), Raceways
- Floor Raceways Trunking Systems
- Cable Distribution & Termination - Open Frame Racks - 2 & 4 Poles, D Ring



certified by IGBC, CII

High performance & Functionality **Ultrafast installation** Minimum Human Labour
Highly customizable Modifiable **Relocatable** Minimum components

distributor



view auth distributor list online

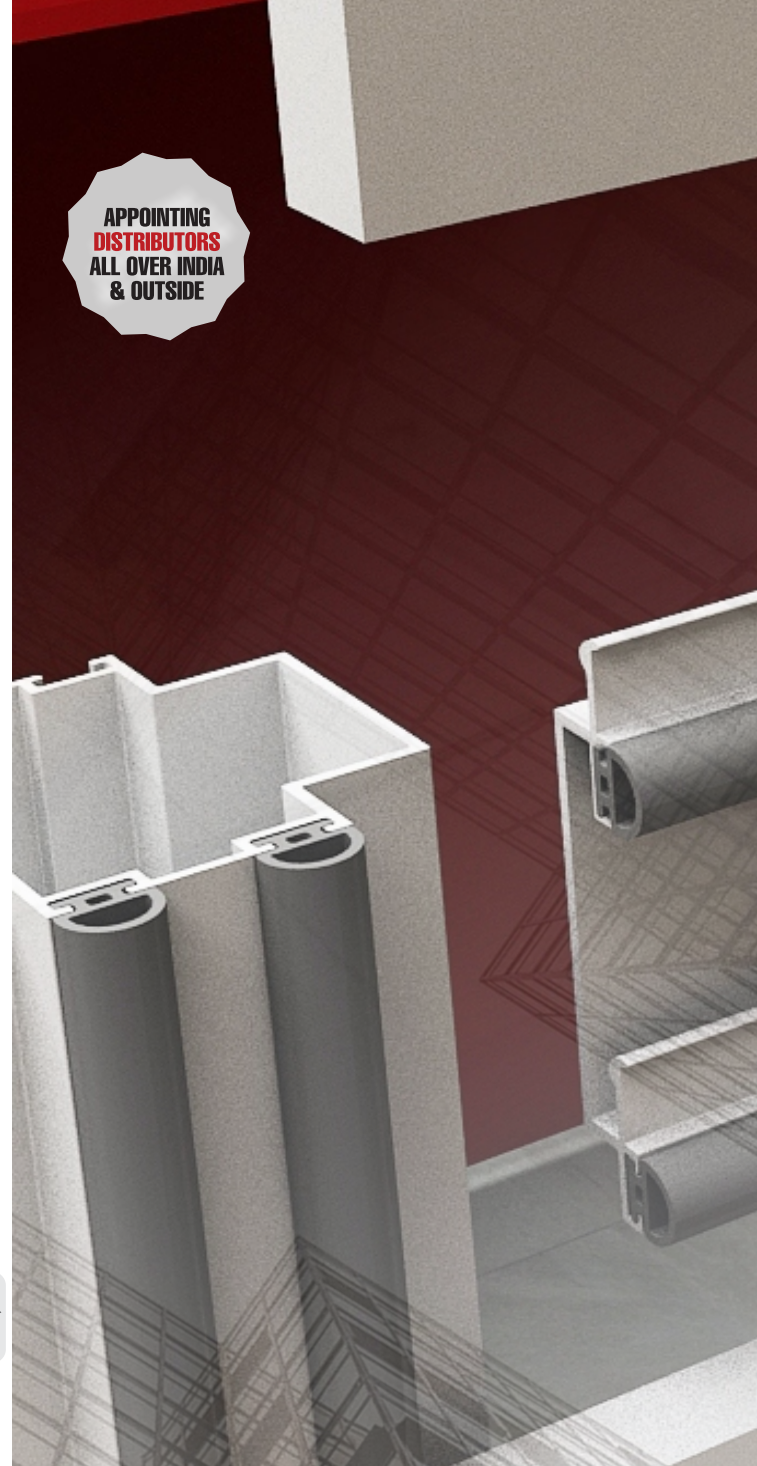

DESIGNERS & MANUFACTURERS OF LARGEST NUMBER OF GREEN CERTIFIED MODULAR FURNITURE & INTERIOR SYSTEMS IN INDIA

www.iqubx.com



All copyrights, trademarks, Intellectual property rights, patents reserved in name of IQUBX pvt ltd and its directors. Any copying of logo, images, designs, product designs without explicit written permission of the directors of IQUBX pvt ltd shall be a punishable offence. All the product designs are IPR protected