

download  
master  
brochure



**innovation**  
**+ sustainability**



give your interior designs **modular wings**

*All copyrights, trademarks, Intellectual property rights, patents reserved in name of IQUBX pvt ltd and its directors. Any copying of logo, images, designs, product designs without explicit written permission of the directors of IQUBX pvt ltd shall be a punishable offence. All the product designs are IPR protected*



**Innovative + Green**  
**Customizable**  
**Modular**  
**Interior**  
**Systems**



[www.iqubx.com](http://www.iqubx.com)

# Applications



Offices | Residences  
Hospitals | Institutes | Universities  
Retail | Hotels  
Smart Cities | Airports  
Railway & Metro Stations

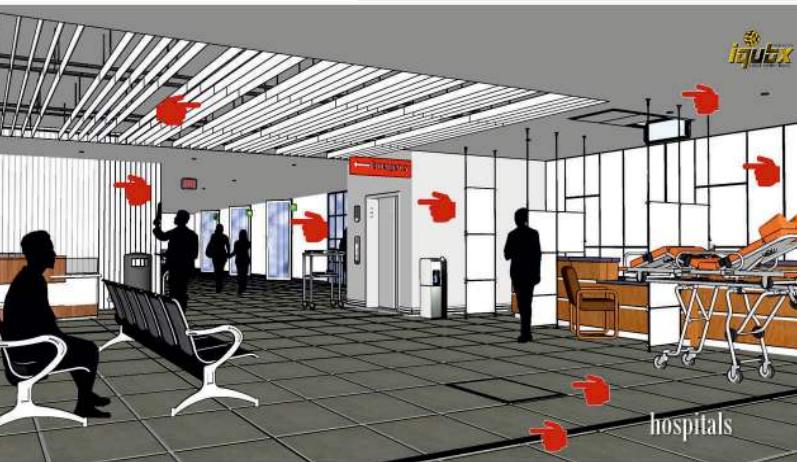
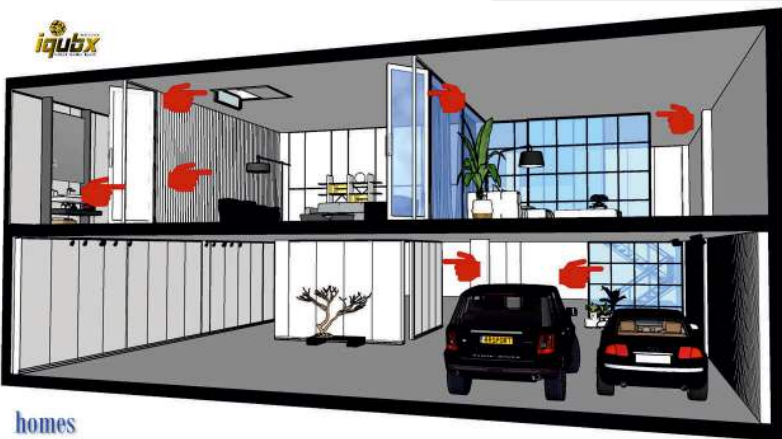

## Features

-  Innovative, Unique patent applied designs
-  Greenpro certified, recycled aluminum 6063 alloy T6 tempered
-  Sophisticated engineering
-  Very High performance
-  Made completely in India

## Benefits

-  Ultra Fast instalation on site
-  Minimum manpower on site
-  Very Economic pricing
-  Highly Customizable as per requirements
-  Modularity - Modifiable even post-installation
-  Relocatable
-  Minimum Turn-around-time
-  Minimum components- better logistics & maintenance
-  Made in India, future availability of components
-  Caters to Sustainable project requirements
-  **New Custom MODULAR solutions designed as per your requirements**

# Modular Baffle Ceilings



Lacquered glass



Cork

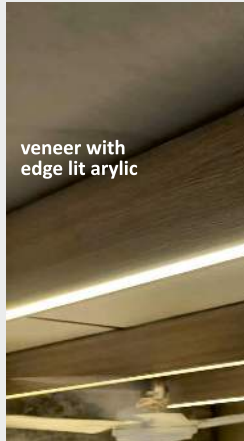

veneer with edge lit acrylic

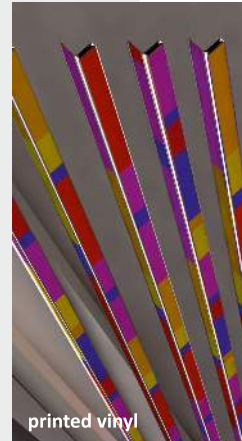

printed vinyl

## BFC2 120 x 41.5 mm

Patent applied baffle with changable 4mm material finish on 3 surfaces flexibility of changing finishes later

Lacquered glass  
Cork  
ACP sheet  
Laminated MDF  
Veneer  
Printed vinyl  
Edge lit acrylic

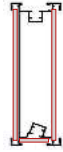

## BFC12

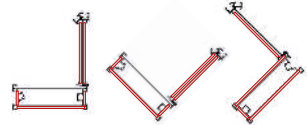

Cork with edge lit acrylic



Installation with proprietary clips or MS bolts to subframe

## BFC3 any height x 39 mm

Baffle of any height possible  
Cost-effective  
Interesting shaping  
Acoustic NRC as per infill material  
12mm material finish

Gypsum / Cork  
ACP / Laminate / Veneer on WPC  
Gypsum board  
Printed vinyl

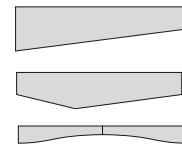

## BFC4 100 x 25

Any RAL shade, wooden powder coat amodize finishes

Conversion of standard extrusion tubes into a baffle with help of proprietary clips is possible

100 x 50

150 x 75

200 x 50

size of any available generic section in market



wooden finish

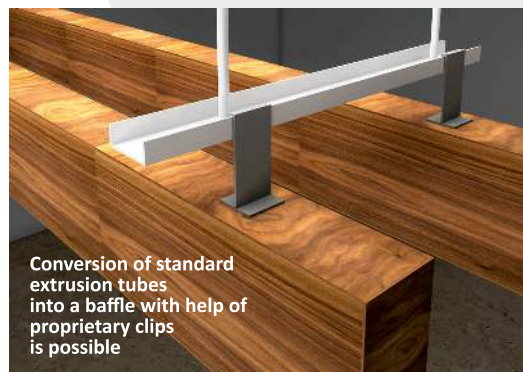

Conversion of standard extrusion tubes into a baffle with help of proprietary clips is possible

Patent applied

Innovative

Innumerable exotic finishes

Flexible shapes & sizes

Greenpro certified by IGBC



# Ceiling Trapdoor access panel

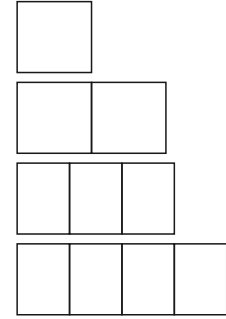
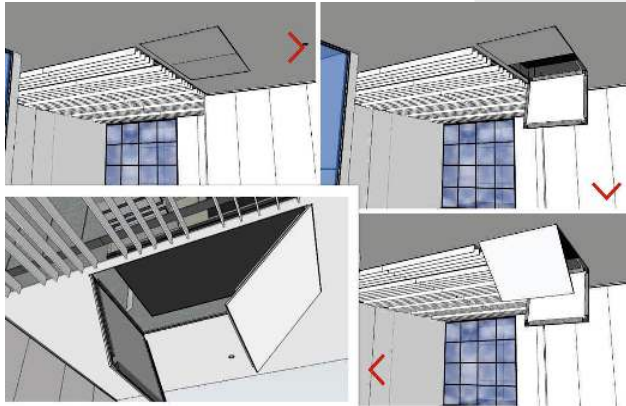

Multiple shutter configurations as per size requirements is possible

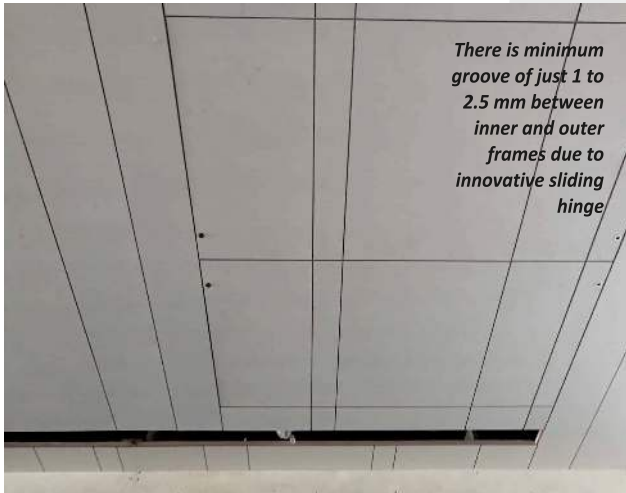

### CTD23

Patent applied, with flange of approx 5mm

### CTD24

Thin groove all around, innovative sliding hinge

### CTD24A

Acoustic model

### CTD25

Latest design with strong construction, modifiable on site

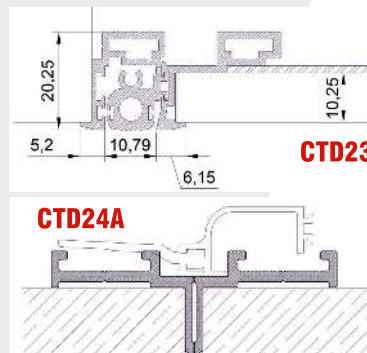
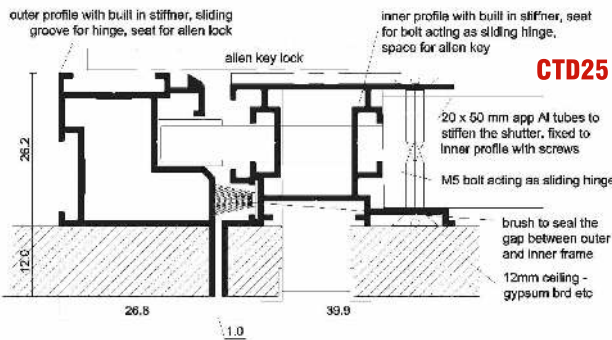

### Unique design

### Custom sizes

### Big sizes (even above 10 feet)

### Light weight

### Strong shutters don't warp

### Only thin groove visible

### Greenpro certified by IGBC

### Any material finish 12mm

Gypsum / MR board  
ACP / Laminate / Veneer on WPC  
WPC



# Modular Glass Partitions



- GP1436 14 x 36 mm
- GP1750 17 x 50 mm
- GP2160 22 x 60 mm
- GP2175 22 x 75 mm
- GP18100 22 x 100 mm
- GP4028 40 x 28 mm
- GP2510 25 x 44 mm
- GP2512 25 x 50 mm

- GPC1750 17 x 50 mm
- GPC2060 20 x 60 mm
- GPC1415 14 x 15 mm

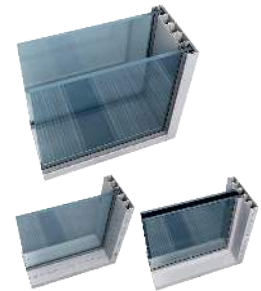

GP18100, GP2160 with single, double, VIG in same section, allows upgradation



GPC2060  
20 x 60 mm

GPC1415  
14 x 15 mm

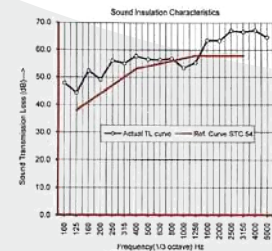

GD18100D with double 12 mm glass certified STC 54, all models have high STC



GP2160V 22 x 60  
with VIG glass also available

GP2160S 22 x 60

GP2160D 22 x 60

GP4028 40 x 28

GP2510 25 x 44  
GP2512 25 x 50

GP2512D 25 x 100



ULTRASLIM  
Double colour  
GP1750 17 x 50



GP18100VIG  
22 x 100

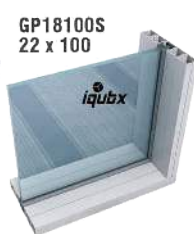

GP18100S  
22 x 100

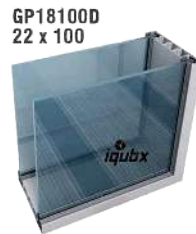

GP18100D  
22 x 100



## Proprietary designs

Models with single, double, VIG in same section allows upgradation

Models with two colour possible finish in main section & moulding

Models with Crittal / grid  
High sound insulation (STC)

Greenpro certified by IGBC



GP2175 22 x 75  
launched with  
75 wide door frame

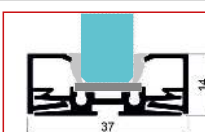

GP1436 14 x 36 mm  
ultra slim  
very cost-effective  
45 deg chamfered finish



# Modular Glass Stile Doors



**GD01**  
lock stile 145 x 40 mm  
hinge stile 85 x 40 mm  
rail 80 x 40 mm

- Integrated handle
- Option of single glass 8 - 10 mm / double glass 6 mm
- Glass pane can be changed without demounting door
- Unique and smart design
- Can be made into a sliding door



**GD02**  
lock & hinge stile 75 x 40 mm  
rail 80 / 90 x 40 mm

- Single glass 8 - 10 mm
- Glass pane can be changed without demounting door
- Gasket options on leading edge and stile face
- Can be made into a sliding door
- Can have concealed door closer and drop-seal



**GD03**  
lock & hinge stile 26 x 40 mm  
rail 60 x 40 mm

- Single glass 8 - 10 mm
- Ultra slim design
- Very strong construction & joinery
- Can be made into a sliding door and sliding partition
- Can have drop-seal



**DF01**  
34 x 50 mm  
11 mm rebate

- Can be independently constructed
- Can be used for glass, solid partitions as well as masonry
- Strong sturdy construction
- Accommodates any door upto 45 mm
- Double acoustic seal provision for High sound insulation

# Modular Door Frames

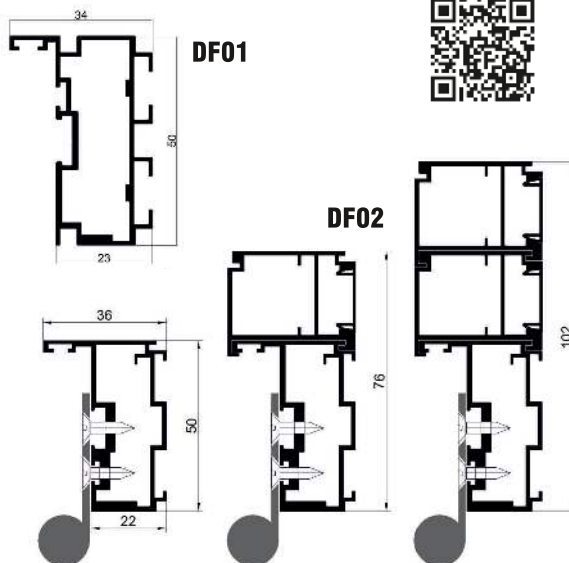
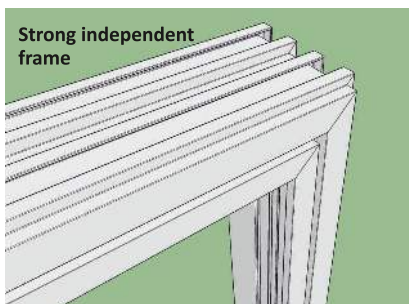

**DF02**  
36 x 50, 76, 102 ... mm  
14 mm rebate

- Can be independently constructed
- Can be used for glass, solid partitions as well as masonry
- Modular extension in multiple of 26 mm can be used for glass, solid partitions as well as masonry
- Strong sturdy construction
- Accommodates any door upto 45 mm
- Double acoustic seal provision for high sound insulation



# Dry wall cladding partition



Complete dry framing for wet area partition walls with embedded services is possible, including counters etc



## DWP01

Dry wall cladding system can clad stone, tiles pasted on a board, cement board .. on existing surface

Dry wall cladding along with IQUBX open frame structure system can create partition walls for dry or wet areas

Easy to access services like plumbing etc by removing & refixing panels

Dry & modular construction makes it very fast to install, completely relocatable, modifiable

Can be used for hotel / residential / hospital / office wall partitions

Wet areas like  
Toilets & pantry blocks  
Makeshift or permanent hospitals  
Residences  
Office wet area blocks

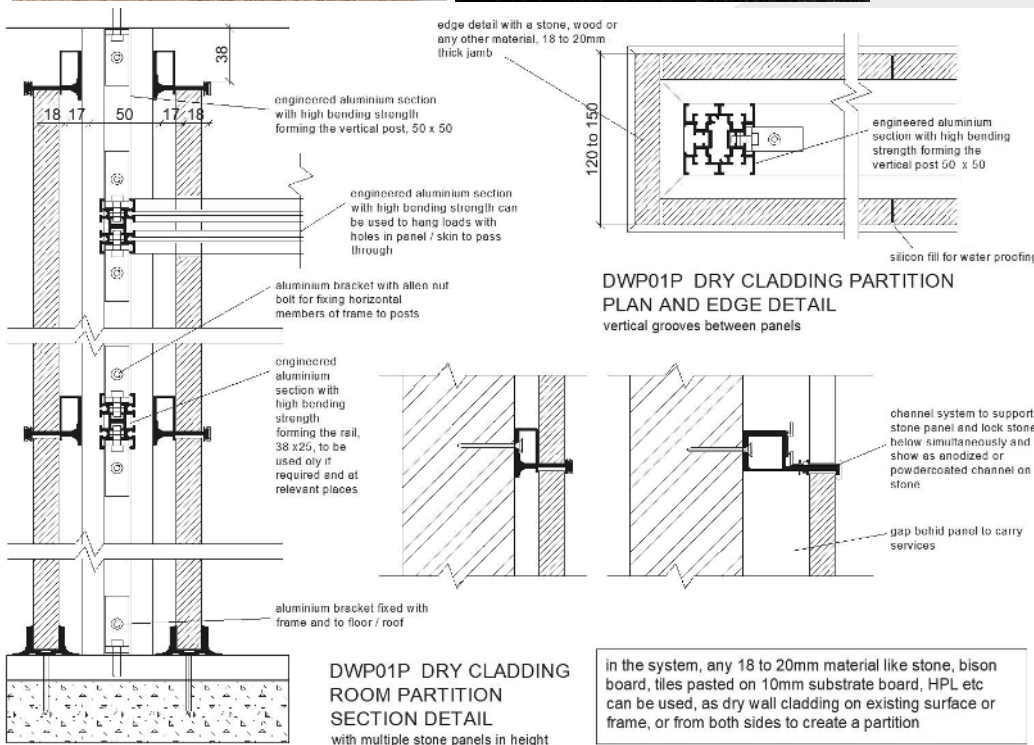

## Misc products

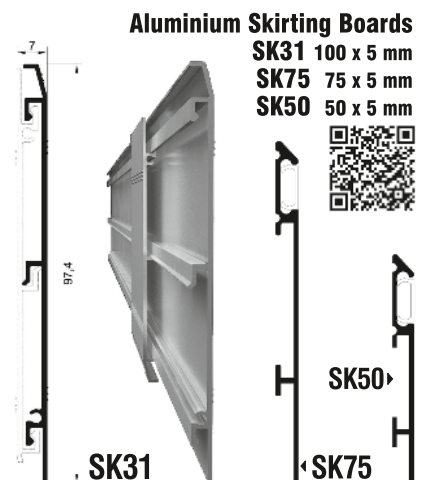
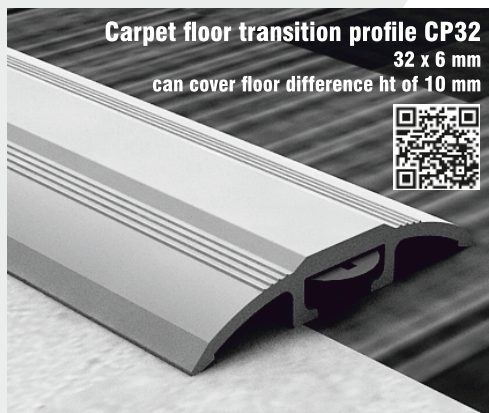

# Demountable solid Partition

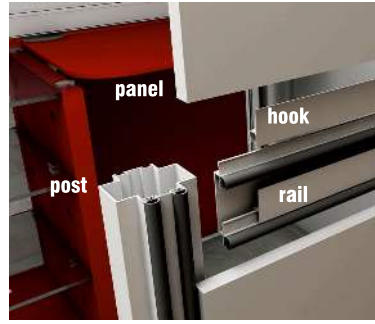
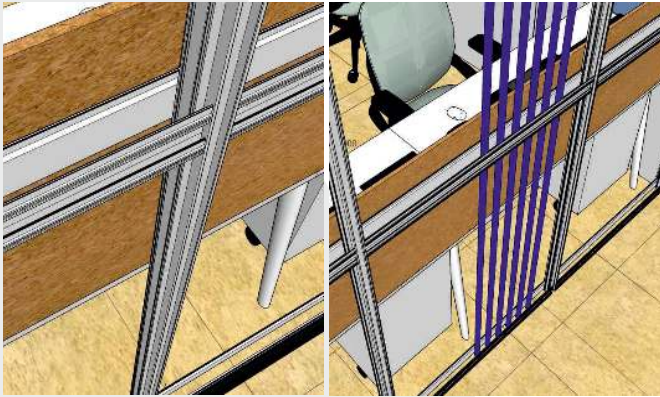

## WP03P

**Post & rail with panels**

**Modular construction**

**Very fast installation**

**Cost effective**

**Continuous cavity for conduits, other services & acoustic insulation**

**Panels fixed with gaskets on frame for better sound insulation**

**Panels can be removed & refixed anytime to allow maintenance, can be changed in finish easily**

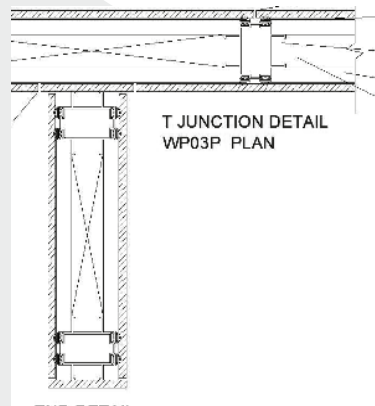
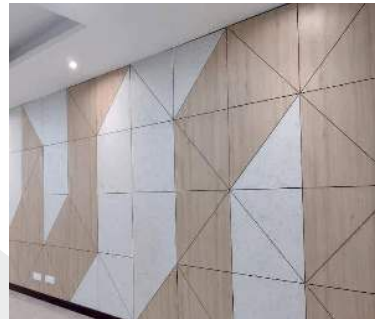

Panels of 6mm to 25mm of any finish can be installed by user - Prelaminated / Postlam board, Veneer / lacquered glass, soft board, cork board, HPL etc



# Paneling



## WP01

Post & panel framing  
Removable panels fixed with hooks, making maintenance easy  
Doubling it can create partition as well

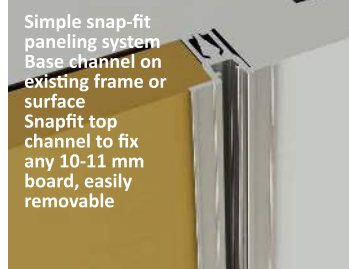
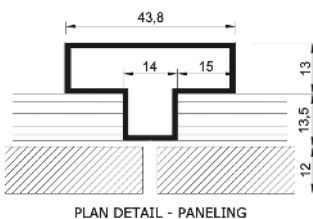
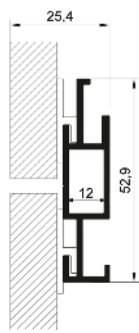

Simple snap-fit paneling system  
Base channel on existing frame or surface  
Snapfit top channel to fix any 10-11 mm board, easily removable



Gypsum board  
Soft board  
Lacquered glass  
Prelam particle  
Anyother panel

## WP02

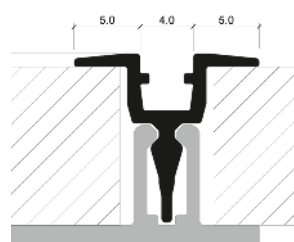

Aluminium panels for cladding straight or curved surfaces

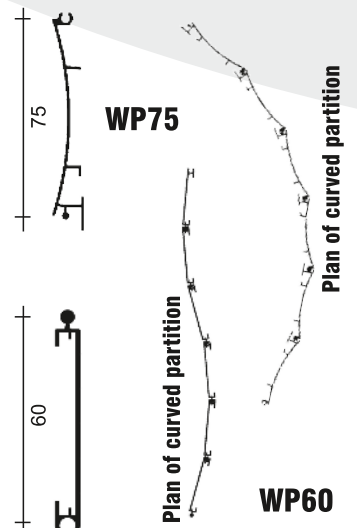

## WP75

## WP60



# Workstation understructure



WSL01

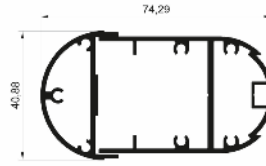

**WSL01 tapered leg**  
75 / 45 x 40 mm

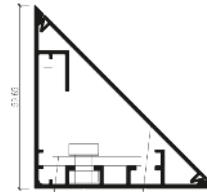

**WSLT60**  
triangular loop leg  
60 x 60 mm

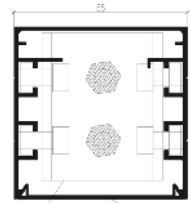

**WSLQ55**  
Square leg  
55 x 55 mm



**Completely Aluminium**  
**Versatile, Strong & sturdy**  
**Modular knock-down**  
**Modifiable on site**  
**Beams act as raceways**  
**Dual colour possible**  
**due to compound legs**



WSLQ55



WSLT60



Dual colour due to compound construction of legs and beams can add finesse and fine detailing



## Modular Partitions

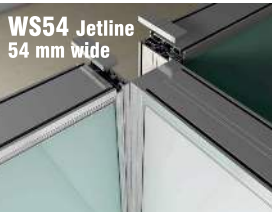

**WS54 Jetline**  
54 mm wide



**WS26 Airline**  
26 mm wide



**Fliptop box POP23**  
130 to 156 mm wd



Unique design with table top finish embedded in lid  
Modular construction  
Customized length upto 2400 mm  
Customized width



**Fliptop Box**

# Open Modular Frame Structure



## OFRS

**Highly modular construction**

**Quick install & uninstall**

**Strong sturdy modular joinery with minimum tools**

**Complete reusable, relocatable, modifiable**

**Good load bearing strength to mount accessories like fans, ACs, racks, partitions, doors etc**

## Usecase

Industries & sheds (PEB)  
for office cabins, stores etc

Malls  
for kiosks & Retail spaces

Airports, Railway stations,  
Metro stations  
for kiosks, Retail outlets

Exhibitions  
Stalls & Booths

Offices  
for office booths, floating conference rooms, even complete offices

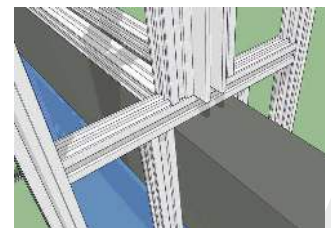

Main frame made of 50 x 50 IQUBX aluminium green certified proprietary section of open frame rack structure system. This is fixed to walls & floor with expansion bolts, creating strong independent standing framing

Strong modular joinery doesn't require drilling holes etc for bracket fixing, making it feasible for repositioning brackets as per requirements. This allows easy modification and reuse / relocation



80' x 25' partition created in Hyderabad Airport for GMR under operational airport conditions



office pods

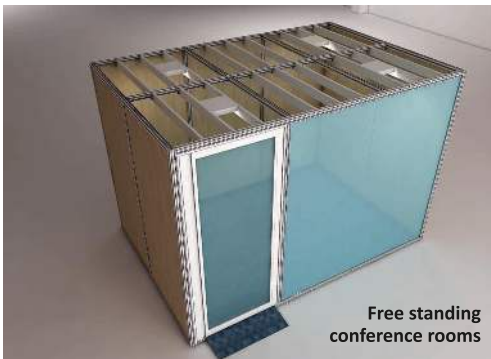

Free standing conference rooms



Free standing office cabins in industrial sheds

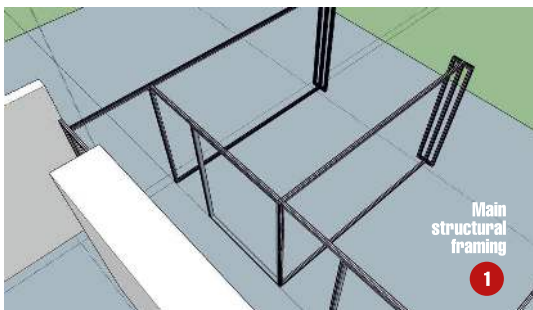

Main structural framing 1

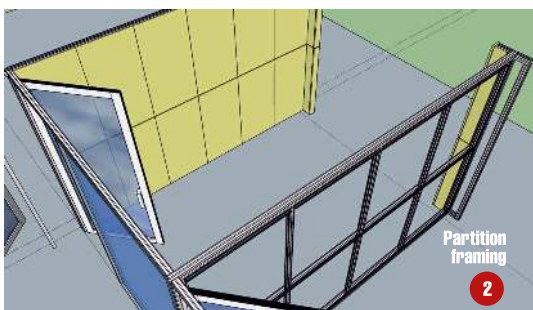

Partition framing 2

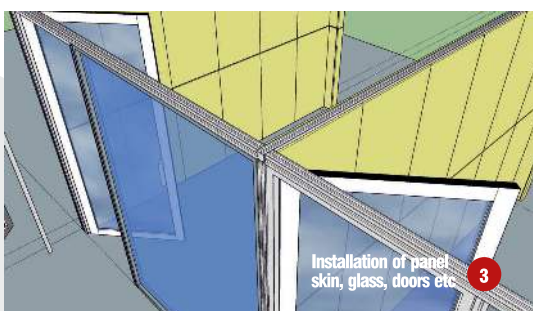

Installation of panel skin, glass, doors etc 3

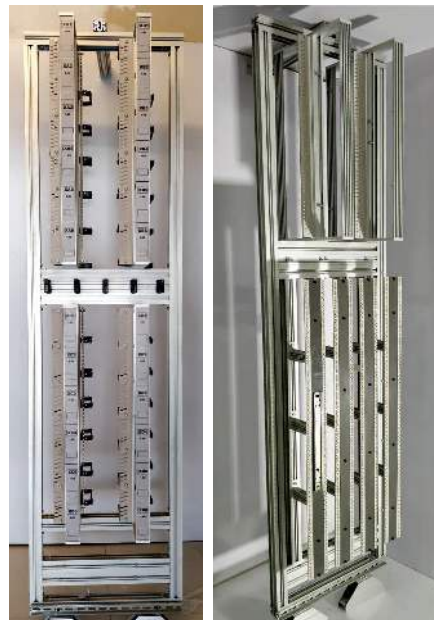

Cable Distribution / Termination racks for DMRC / Siemens



Section of 50 x 50 OFRa

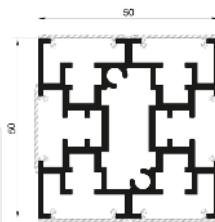

# Floor trunking system



Seam less, clean, aesthetic flooring for a contemporary interior

stone

Unobstructed floor finish with high load capacity, doesn't squeak or creak



Recyclable certified Green Building Material Ideal for LEED Projects



No loose covers means no accidents no tripping

OVER HERE



Most economical solution as no wastage and can be self fabricated on site

Lid in cavity doesn't come loose, thus, no entry of dust, mites, bugs, rodents which may damage the wires and cause disease



Double lid or infact any design & shape possible as per requirement

## Floor Junction box

Can accommodate floor finishes like stone, tile, wood, carpet etc

- Highly modular construction
- Any size, odd shapes
- Modifiable on site
- Patent applied
- Good load bearing strength
- Usable in office, Airports, railway stations or even residences

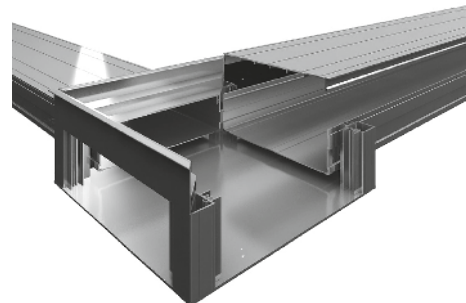

**JB022 L/D/H (Lid / Double lid / Hinged)** for bigger sizes and floor finishes upto 19mm high load bearing 30 mm collar depth, ideally 60 mm ht onwards sizes of even 600 x 600 or more

**JB023 L/D/H (Lid / Double lid / Hinged)** for medium sizes and floor finishes upto 10mm medium load bearing 20 mm collar depth, ideally 50 mm ht onwards sizes upto 450 x 450 recommended

JB22 & JB23 have similar construction, but different collar depth & load bearing capacity

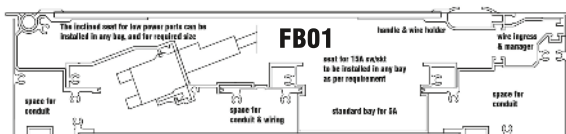
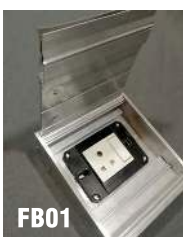

IQUBX FB01 electrical floor box outlet - 2 bay section



FB02



FB01

## FB01 Electric Floor box

Modular customized flexibility 55mm ht, length upto 2400 mm Insitu continuous failproof hinge

Width with any number of bays, first bay of 165 mm, additional bays of 93 mm each x n Two bay 258 x 258 mm can be retrofitted in existing standard floor boxes

## FB02 Electric Floor box

Modular customized flexibility 95mm ht, length upto 2400 mm Insitu continuous failproof hinge Width 1 bay 158, 2 bay 258 mm Upto 10mm floor finish in lid

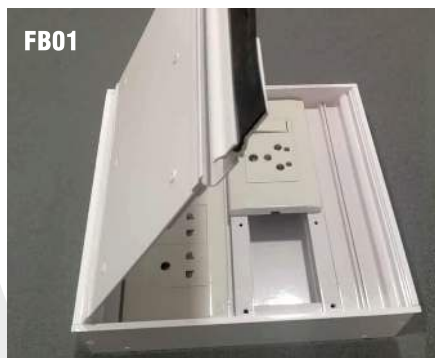

FB01

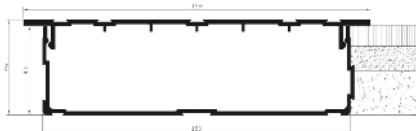

Other sizes of 55 x 55, 100 x 50 also available

## RW011 Floor Cable Raceway 45 x 150

45 mm ht, 150 mm wide, stackable in width 150,300 ... Can be laid exposed to floor finish, on walls, partitions Snap-fit lid for easy access & maintenance of cabling

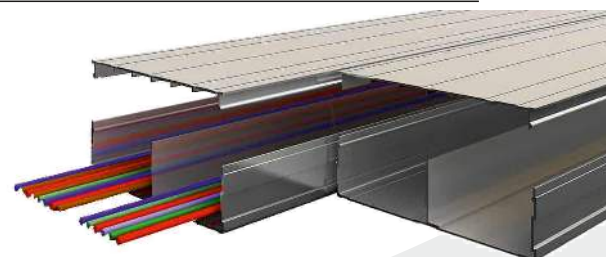

**MODULAR BAFFLE CEILINGS**  
**CEILING TRAP DOORS**  
**GLASS PARTITION SYSTEMS**  
**DOOR AND DOOR FRAMES**  
**DEMOUNTABLE PARTITION SYSTEMS**  
**PANELING SYSTEMS**  
**DRY WALL CLADDING PARTITIONS FOR WET AREAS**  
**WORK STATIONS LEG SYSTEMS**  
**FLIPTOP BOX FOR WORKSTATIONS**  
**MODULAR WORKSTATION PARTITIONS**  
**ELECTRICAL TRUNKING SYSTEMS**  
**FLOOR JUNCTION BOX**  
**FLOOR BOX**  
**FLOOR RACEWAYS**  
**OPEN MODULAR FRAME STRUCTURE SYSTEM**  
**CABLE TERMINATION RACK - DISTRIBUTION RACK**  
**SKIRTING BOARD**  
**CHAIR RAILS, CORNER GUARD, CARPET TRANSITION PROFILE**

A few of our **prestigious** clients



Exports to Middle East, Canada, Maldives, Nepal

Published June 2023



We also provide **custom modular solutions** for your unique requirements at no cost to you



[www.iqubx.com](http://www.iqubx.com)

Designers & Manufacturers of Largest number of Green Certified Modular Interior Systems in India

**IQUBX PVT LTD**

Plot No 22, Khasra no 27/10  
Industrial Area, Nangli Sakrawati  
Near Campa Cola Factory  
Najafgarh, New Delhi 110043

[www.iqubx.com](http://www.iqubx.com)  
<https://www.facebook.com/iqubx/>  
<https://www.linkedin.com/company/iqubx/>  
<https://www.instagram.com/iqubx/>

**Modular Green Building Furniture & Interior Systems**

+91 9999001967, 8506074444, 7065444402 | [info@iqubx.com](mailto:info@iqubx.com)

The only certified Green Products in their categories in India

All copyrights, trademarks, Intellectual property rights, patents reserved in name of IQUBX pvt ltd and its directors. Any copying of logo, images, designs, product designs without explicit written permission of the directors of IQUBX pvt ltd shall be a punishable offence. All the product designs are IPR protected

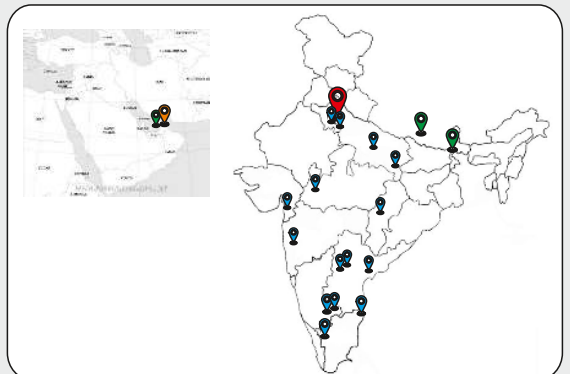

**distributor**



view auth distributor list online